



ASSEMBLY INSTRUCTIONS



Crystalclear Enterprises
Hamilton Lodge
58 Queens Road
Chadderton
Oldham
Tel. 0161 345 1110
E-Mail:

sales@cheshireluxurypools.co.uk
www.cheshireluxurypools.co.uk

Please ask us for further information regarding up-grading your: -
Plumbing, Heating, water sanitisation systems and all your pool needs.

ABOVE GROUND POOL SERIE CANARIAS

INDEX

1. SAFETY GUIDELINES -----	p.3
2. DETERMINING THE INSTALLATION SITE FOR THE SWIMMING POOL -----	p.4
3. TOOLS -----	p.5
4. COMPONENTS -----	p.6
5. PREPARE THE AREA BEFORE THE INSTALLATION -----	p.6
6. PLACEMENT OF THE LOW PROFILES -----	p.7
7. ASSEMBLY OF THE STEEL WALL (CH) -----	p.8
8. INSTALLATION OF THE LINER (L) -----	p.9
9. INSTALLATION OF VERTICALS (VER), TOP PROFILES (HOR) & TOP CONNECTORS (EMB) -----	p.10
10. LAST DETAILS -----	p.11
11. INSTALLING THE RETURN VALVE -----	p.11
12. INSTALLING THE SKIMMER -----	p.12
13. SWIMMING POOL MAINTENANCE -----	p.13
14. CARE DURING WINTER MONTHS -----	p.14
15. TO EMPTY, DISASSEMBLE AND STORE YOUR POOL -----	p.15

	<p>ATTENTION: READ THESE INSTRUCTIONS CAREFULLY BEFORE PROCEEDING TO ASSEMBLE YOUR SWIMMING POOL. REMIND ALL POOL USERS THAT THESE SAFETY INSTRUCTIONS MUST ALWAYS BE FOLLOWED-UP. KEEP THESE INSTRUCTIONS FOR FUTURE CONSULTATIONS. YOUR CHILDREN'S SAFETY DEPENDS ON YOU! RISK IS HIGHER WHEN CHILDREN ARE UNDER 5 YEARS OLD. ACCIDENTS CAN HAPPEN TO ANYBODY SO IF INSTRUCTIONS ARE NOT FOLLOWED THIS MAY CAUSE HEALTH RISKS, ESPECIALLY FOR CHILDREN!</p>
---	---

1. SAFETY GUIDELINES



Remember that safety is the most important factor when installing the swimming pool. Safety must be given priority over any decorative aspect. Do not lean, jump, sit, stand or walk on profiles. They have not been designed to that effect.



Do not dive or jump headfirst in your swimming pool; do not jump from a ladder or elsewhere. This pool is not deep enough to dive without risk of accident. The self-adhesive sign "Unsupervised, your child in danger" must be placed close to or on your pool. For replacement adhesives, please contact our factory.



Do not use your swimming pool when being under the effects of alcohol, medicines or drugs. To avoid drowning and injuries, do not leave tables, chairs or other objects near the pool to prevent children from climbing into the pool. Do not install a slide on your swimming pool.



To avoid electrocution risk, do not manipulate electrical equipment near to your swimming pool or with a wet body. Make sure that all electrical equipments are protected by a grounded switch. When bathing, never use metallic or punching foot wear. If your pool has a cover on, do not allow anybody, and especially small children, to walk or play on it. Assign one entrance and exit for our swimming pool. This area must be kept totally clean. Remove all objects that could hurt barefooted people.



Do not make holes in your swimming pool wall to install lights or any other devices. It could result in serious injuries, inundation, electrocution or property damage.



For more security, we recommend to install a 122cms high fence or wall around your swimming pool made of a resistant material. All access doors/gates should have a lock installed at least at 122cms high in order to prevent small children from opening them. If doors, windows and garden gates make part of the fence, make sure that they can be closed or locked with a key or bolt.



Do not use your swimming pool at night or when visibility is not good. The water of your swimming pool should be always kept clean in order to see the bottom and appreciate its depth. Users should be capable of seeing that the pool is not deep enough to dive in. If you decide not to take into account this safety instruction, then it's your responsibility to provide users the appropriate instructions on the correct use of this product and supply sufficient light. For lighting recommendations, consult your local licensed electrical contractor on the appropriate light so as to fulfil all local and national norms of electricity and other security requirements.



If your pool is equipped with a ladder, then follow-up all safety guidelines and assembly instructions indicated in the manual.

A ladder must be used to get in and out of the swimming pool. When not in use, the ladder should always be removed and kept in an inaccessible place.



In order to maintain its stability, the ladder should be placed on a solid, levelled base at all times. Only one person at the time should be on the ladder.

Install the ladder where the entrance/exit of your swimming pool will be.

Never use your ladder for other aims. The pool ladder has not been developed for other applications.



If your swimming pool is equipped with a filter, make sure that the swimming pool is filled with water and your filter correctly connected as indicated in the manual.

During the bathing season, the filter must work every day, long enough to renew all the water at least one time.



Attention: All filter systems fulfill normative of installation NF C 15-100. It stipulates that all electrical item that is to less than 3.5mtrs from the swimming pool and freely accessible, must be fed on very low tension. 12 volts.

All electrical item fed on 220 V must be place at least, at 3.5mtrs from the pool's edge. A permission of the manufacturer is needed to modify any of the components of the filtration system.

Verify all parts of your pool on a frequent basis in order to detect possible failures and make sure all components are installed correctly. Always replace components with original spare parts.

This swimming pool has been designed for private use only. Do not use for commercial activities.

Avoid accidents and be prepared to react in case they occur!

SUPERVISE AND ACT

- Never leave a child alone and unsupervised.
- Assign one person to be responsible for the user's safety.
- Increase supervision according to the number of pool users.
- Supply inflatable to those who do not know how to swim.
- Teach your children how to swim as early as possible.
- Wet your neck, arms and legs before going inside the water.
- Learn first aid techniques, especially those applied to children.
- Do not allow diving and jumping.
- Do not allow sprints or violent games near or inside your swimming pool.
- Children that cannot swim should not be allowed to enter the swimming pool without life jacket and without the company of an expert swimmer.
- Do not leave toys inside or near the swimming pool.
- Keep water clean and healthy permanently.
- Store chemicals for water treatment out of children's reach.

KEEP:

- Your telephone close to the swimming pool in order not to interrupt supervision.
- Inflatable's and pole's near the pool.

IN ADDITION, WE RECOMMEND THE FOLLOWING EQUIPMENT:

- Manual or automatic cover correctly installed.
- Electronic device detecting passers-by and persons falling in the swimming pool. (This additional equipment won't substitute constant supervision, under any circumstances.)

IN CASE OF ACCIDENT:

- Take child out of the water as quickly as possible.
- Call for help immediately and follow the instructions given.
- Replace wet garments by warm and dry ones.

MEMORIZE AND KEEP FIRST AID TELEPHONE NUMBER CLOSE TO THE POOL:

- Fire brigade.
- Ambulance, doctor...

2. DETERMINING THE INSTALLATION SITE FOR THE SWIMMING POOL

The swimming pool must only be installed above ground and on a hard, solid ground. The swimming pool must be installed near a drain or sewage system to avoid flooding in case of breakage/leakage.

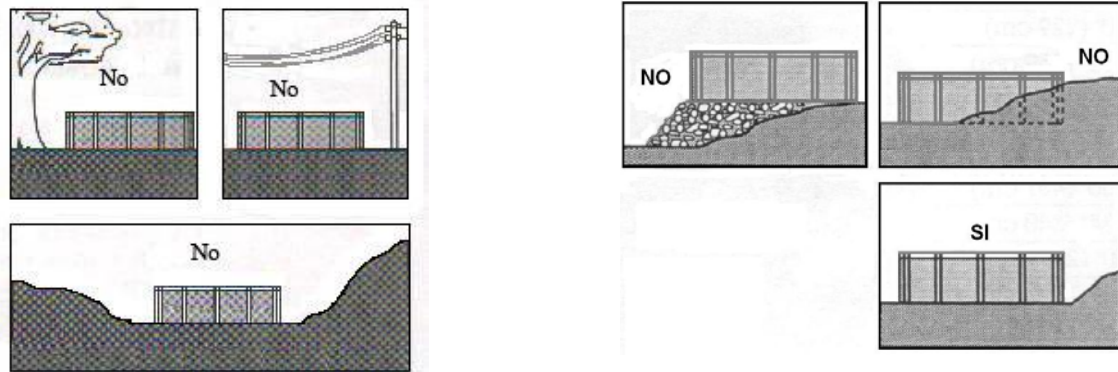

A large area is ideal. However, if a flat area, large enough for the swimming pool is not available, then choose an area where minimum digging is required. Under no circumstances, the swimming pool must be installed below ground level. The maximum weight that the installation site can support must be taken into consideration.

Remove roots, grass and stones in the selected area, including those under the ground. The weight of the water will compress these elements between the liner and the earth under the swimming pool, resulting in damages. Grass left underneath the pool liner will rot and give of an unpleasant odour and stones and roots will damage the pool liner.

Do not install your swimming pool on: marshland, tar, gravel and wood. A foundation made of levelled, solid and very compact soil/earth is the best base for your swimming pool. Do not install your swimming pool on a fragile earth or on a site that will not support the weight of the pool.

ELECTRIC WIRES.

The swimming pool must be installed at a minimum distance of 6 meters from any electrical socket. To ensure maximum safety, it should never be installed directly below high voltage or medium voltage overhead electricity wires. In some communities, it is illegal to do so.

UNDERGROUND CABLES.

Check for any buried electrical, telephone cables, or gas pipes on the site before you start digging to level the surface.

TREES.

Overhanging trees and their tenants (birds, insects...) are not the swimming pools best friends. The resin and falling leaves and twigs can cause problems in maintaining your swimming pool's water clean. If there is a filtering system, it will have to be used more often. Install the swimming pool away from the trees.

GROUNDING SOCKETS.

In the case where the swimming pool has or uses a water filter or any other electrical device, and there is no grounded socket nearby, you must have one installed by an authorized electrical technician.



Important:

Determine the location of the swimming pool. **Make sure** that the distance from other houses, fences...etc. is appropriate. **Check** that the ground is level. Contact the competent authorities to receive all the information concerning to the installation of the pool in your house.

3. TOOLS (Not included):

Necessary tools for the work involved :

- 1.- A measuring tape .
- 2.- A spirit level.
- 3.- A marker (felt pen).
- 4.- Adhesive tap.
- 5.- Cutter.
- 6.- Gloves
- 7.- Clothespins.
- 8.- Scissors
- 9.- A metal saw.
- 10.- A wrench.
- 11.- A flat screwdriver.
- 12.- A "star" screwdriver.
- 13.- File.

3. LIST OF COMPONENTS

	Ø 230x120	Ø 350x120	Ø 460x120	Ø 550x120
L (Liner)	1	1	1	1
CH (Metal Band)	1	1	1	1
TO (Screws)	31	31	31	31
AR (Socket pan)	31	31	31	31
TU (Nuts)	31	31	31	31
PU1 (Top plate)	10	10	10	12
PU2 (Low plate)	10	10	10	12

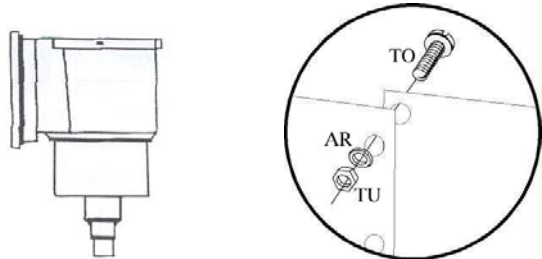
	PL (Small saddle)	11	11	15	17
	PCS	10	10	10	12
	PCA	10	10	10	12
	HOR (Profiles)	10	10	10	12
	VER (Columns)	10	10	10	12
	EMB (Hub caps.)	10	10	10	12
	TO2 (Screws)	90	90	90	108
	SK (Skimmer)	1	1	1	1

4. PREPARATION OF THE AREA AND INSTALLATION

Do not install the swimming pool on a windy day. It is extremely difficult to keep the swimming pool wall upright and it would probably fall, resulting in injuries.

Always place a protective sheet under the liner in order to avoid wear and tear caused by rubbing against the ground and the weight of the water.

It's possible to level the ground in two ways:

- 1st possibility – Prepare a concrete platform. The platform should have the same size as the pool diameter plus 30 cm.

- 2nd possibility – Hammer a peg into the ground in the center of the area where you want your pool. Tie a string equal to the length of the radius of the swimming pool to the peg and mark a circle (fig. 1).

Level the ground in the marked area. The entire area of the swimming pool must be leveled and free of stones and twigs. Locate the lowest point within the circle. Using a leveling tool and a straight wooden board, level the surface down to the level of the lowest point. Do not fill in the holes; dig away higher areas (fig. 2, 3 and 4). Scatter a fine layer of sifted sand over the levelled surface and level again.

Concrete patio stones may be placed at the base of each vertical column of your pool. This is optional, but makes a better foundation for the pool wall. You will need one patio stone of 30 cms. for each base plate.

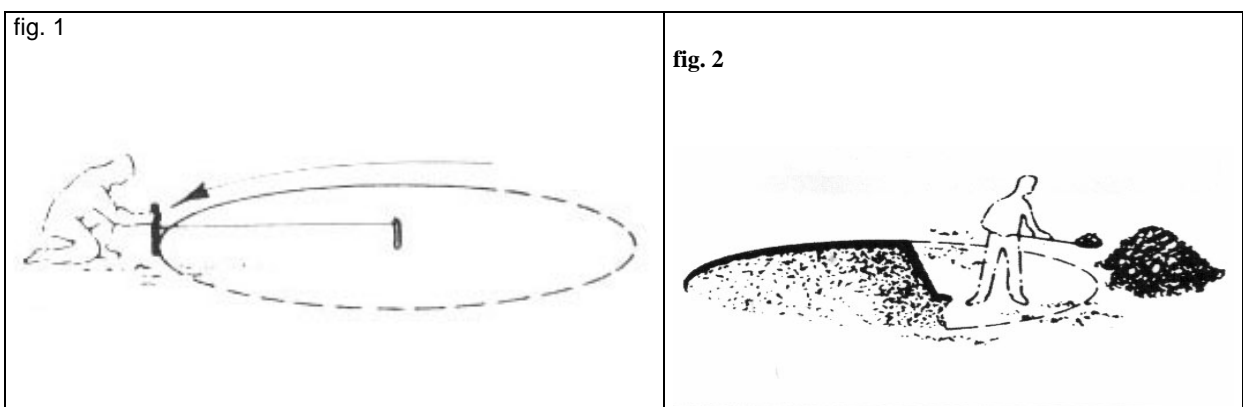

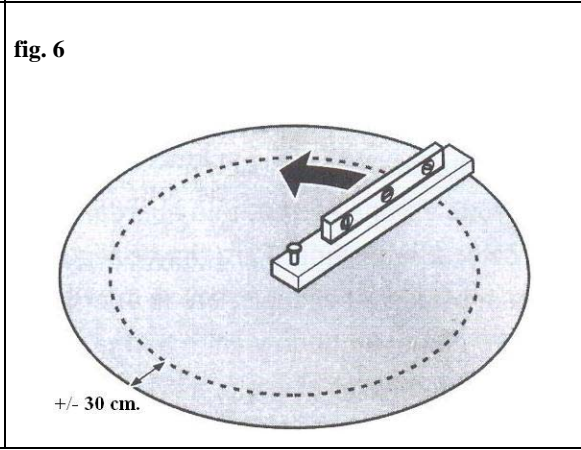
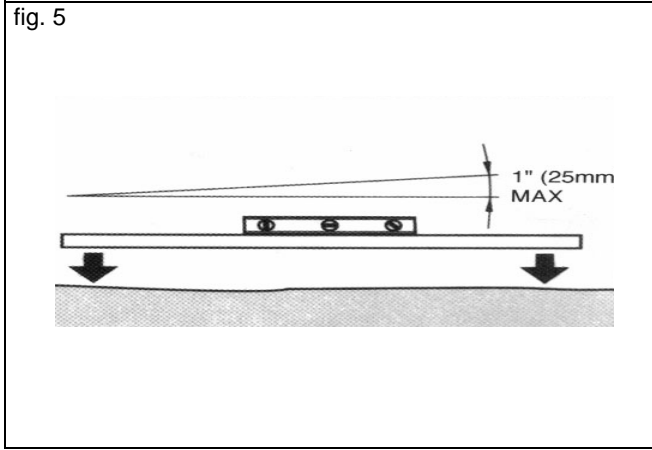
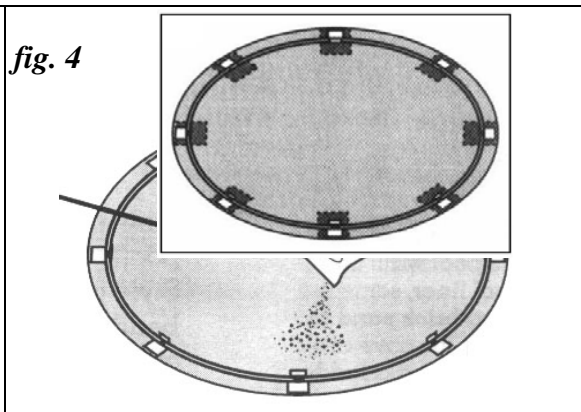
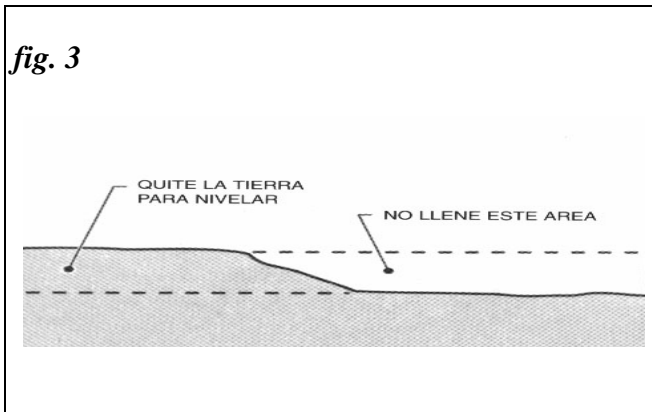

5. ASSEMBLY OF THE LOWER PROFILES

Optional: put tiles at the base of each column. The recommended measure is 30x30 cm.

Temporarily lay out the base rails (PCA) and base plates (PU2) around the circle (fig. 7). Each base plate will show the location for a patio stone. Make a mark in the ground at each base plate. Fig.8

Fig. 7

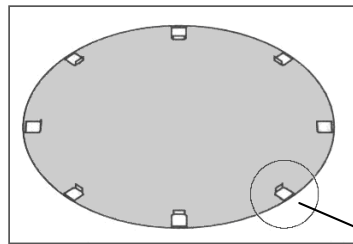
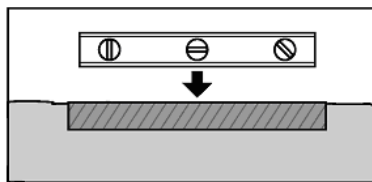
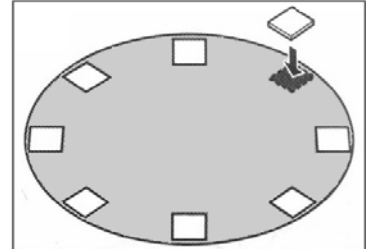

Remove the base rails and base plates and lay out the patio stones around the circle where the base plates were (fig.8).

The patio stones must be sunk into the ground so the tops are flush with the soil around them (fig.9). Use the carpenter's level to make sure the patio stones are perfectly level and flush with the ground and with each other.

Place the base plates equally spaced around the perimeter of your foundation. If you are using the optional patio stones, place one base plate on each stone (fig. 8).

Slide the curved bottom rails (fig. 11) inside the base plates. Leave a 12mm gap between the ends of the bottom rails (fig. 12).

In order to maintain the distance between the base rails (PCA), place a piece of +/- 10 mm in between them (fig. 12). Take care to leave enough space for the pool wall. This piece will be taken away again when installing the verticals.

Foto 1

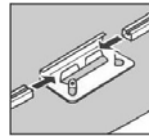
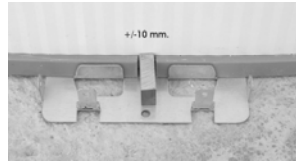

Fig.11

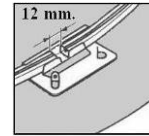

Fig. 12

6. ASSEMBLY OF THE STEEL WALL (CH)

To ensure maximum safety, gloves must be worn during the assembly of the metal sheet. It is possible that some edges are sharp. If so, eliminate them with a file. Do not bend or wrinkle the metal sheet during the assembly; unroll it carefully. Place cardboard under the metal sheet to unroll it easily and make sure that it does not get scratched by rubbing against the ground. Any scratches would cause the sheet to rust. Do not bend or break the upper and lower sections during the installation.

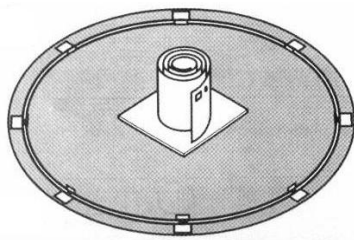
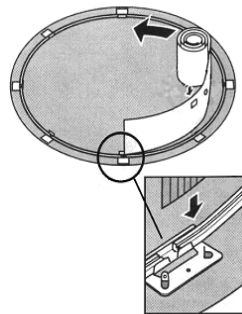

Fig. 13



F.14

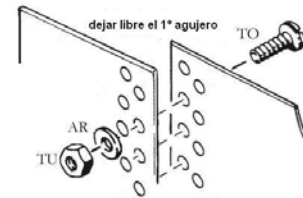

Fig.15

Install the swimming pool on a shiny and not windy day. Do not try to assemble the pool in the wind. Unpack the coiled pool wall and place it vertically on a cardboard at the center of the pool circle (fig.13). The cut-out for the skimmer should be towards the top of the wall.

The starting end of the wall where the holes for screws are located must be installed in the center of the base plate (PU2) (fig.14) where the pump and filter will be positioned.

Working in clockwise direction, start uncoiling the wall, guiding the bottom edge into the curved bottom rail (fig.14 – 15). The starting end of the wall must be positioned over a base plate, and the holes for the filter hoses should be positioned where the pump and filter will be.

Install the wall around the whole circumference until the wall is completely unrolled.

Complete the circle, line up the holes in the two ends of the pool wall and join the ends with a bolt washer and nut through each hole. The head of the bolts must be on the inner surface of the wall, and the washers and the nuts on the outer surface (fig.15). Start installing the screws from the bottom, except for the last hole. Tighten well with the screwdriver.

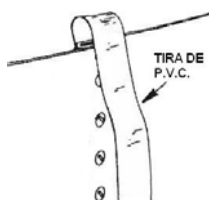

Fig.16

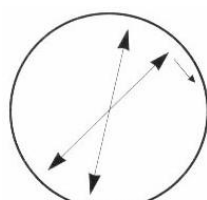

Fig.17

Ajuste del perfilado inferior

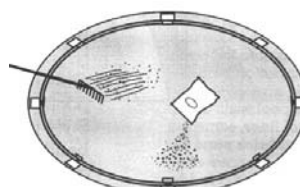
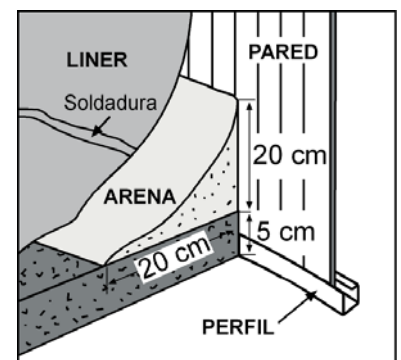

Fig.18

Fig.19



Using a strip of PVC, cover the bolt heads on the inside of the pool wall to protect the liner from rubbing against objects, which is the main cause of tears in the liner (fig.16). Stick the strip with glue or PVC.

Make sure that the swimming pool is completely circular (fig.17). Adjusting the pool to the proper shape may cause the base rails and plates to slip out of alignment a little. Recheck all of the base plates to make sure each one is centered where the base rails meet.

Cover the inside border of the circle using clean sand that is free of any stones or foreign objects. Press the sand into a vertical triangular shaped layer that covers the sections and the inside part of the metal wall. The height of this triangular layer must not exceed 7 cm. (fig.19). In this way, (cover the sand with thin plastic i.e. plastic bag/bin liner so the liner does not touch the sand and possibly react later) you will prevent the liner from sliding under the metal wall and being damaged due to the pressure and the weight of the water.

IMPORTANT: Before placing the liner, cut the skimmer hole with a metal saw or scissor, taking as reference the holes of the wall. Smooth the edges to avoid the liner to be damaged or cut.

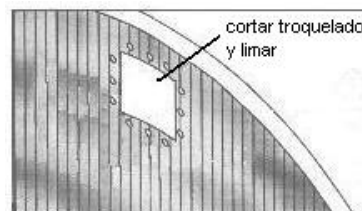

7. INSTALLATION OF YOUR POOL LINER (L)

The liner used has been developed to withstand exposure to heat and ultraviolet rays for a long period of time. Therefore, under certain climates and conditions of use, the liner quality can vary slightly.

Never walk on the liner with your shoes on.

The liner is the most important and delicate part of the swimming pool. Do not use knives or any sharp objects to open the swimming pool bag/container. Carefully separate the liner from the rest of the parts and keep it in a safe place to avoid undesired holes or damages that could be caused by the tools or the metal wall.

Install the liner on a sunny day, minimum 20°C, so that it can easily stretch during the installation. It is made of a highly flexible vinyl material.

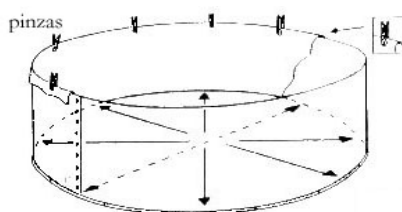
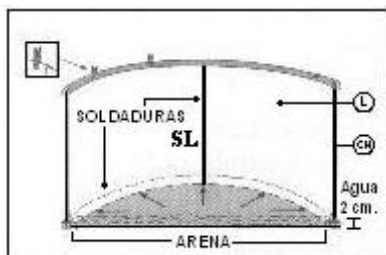

Place the liner (L) in the center of the swimming pool and unfold it towards the sides. Place the rough side towards the outside. The welded part that joins the base of the liner with the side must perfectly match the lower sections and the wall, all around the inside perimeter at the bottom of the swimming pool.

Locate the side welding (SL) so that it is perfectly right and perpendicular on the ground. This will help you to place the liner without folds. Pull away softly all the excess of the liner. Do not pull too hard. The liner must be centered, extended and not wrinkled.

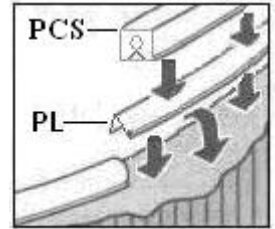

Lift the side of the liner that covers the upper edges of the swimming pool and fasten it to the top of the wall with clothes pegs. Remove the wrinkles by pulling smoothly outwards and adjust the liner. Flatten the pool liner with your hands. Start filling the pool with water, but not more than 2 cms. Make sure the pool wall is level. If the level is off by more than 25 mm across the diameter of the pool, empty the pool, take the wall apart and level the foundations again.

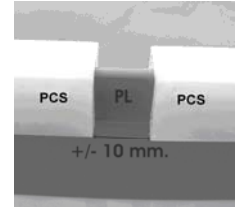

Add 25 cm of water and work out all the wrinkles and smooth the liner to the wall. Fasten the liner with the plastic copings PL and withdraw at the same time the clothespins. Let the liner hang slack for now. Remove the plastic coping around the top edge and adjust the liner.

When all copings PL are installed, mark with felt pen the overlapping part, remove the coping and trim the extra length so there is no overlap. Install the last plastic coping again. Then install the white profiles (PCS) on the plastic copings (PL).

IMPORTANT: CHECK that the water distributes equally. If there were any puddles, that means that the ground has hollows. If the water accumulates on one side, the area is not level. In this case, the pool must to be emptied and disassembled completely to start at the beginning, the ground will have to be levelled again.

8. INSTALLING THE VERTICALS (VER), THE TOP PROFILES (HOR) & TOP CONNECTORS (EMB).

Continue filling the pool with water to 5 cm under the return valve's hole and meanwhile install the verticals.

INSTALLATION OF VERTICALS (VER)

Line up the bottom of one vertical (fig. 23) with the two small tabs on one base plate. The tabs must be on the inside of the vertical.

Line up the screw holes and fasten with one self-tapping screw (TO2) on each side (fig.23).

Hook a top plate (PU1) (fig.24) over the top edge of the pool wall. Place the top plate down over the top of the vertical with the tabs on the inside of the column.

Make sure the vertical is straight up and down. Line up the screw holes and fasten with one self-tapping screw on each side and one on the front (fig.24).

Repeat the last four steps for each of the vertical around the pool wall (fig.23 and 24).

The double screw line of the steel wall will remain hidden under one of the verticals. Put the stoppers on the ends of the top screws.

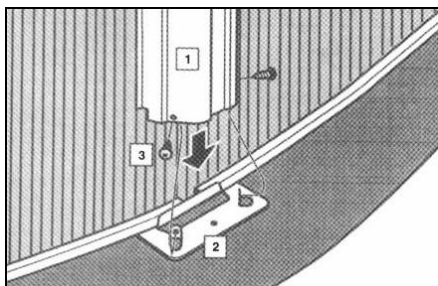

Fig.23

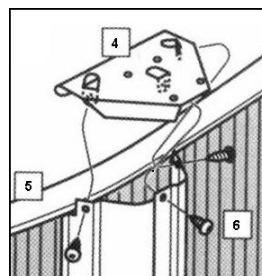

Fig.24

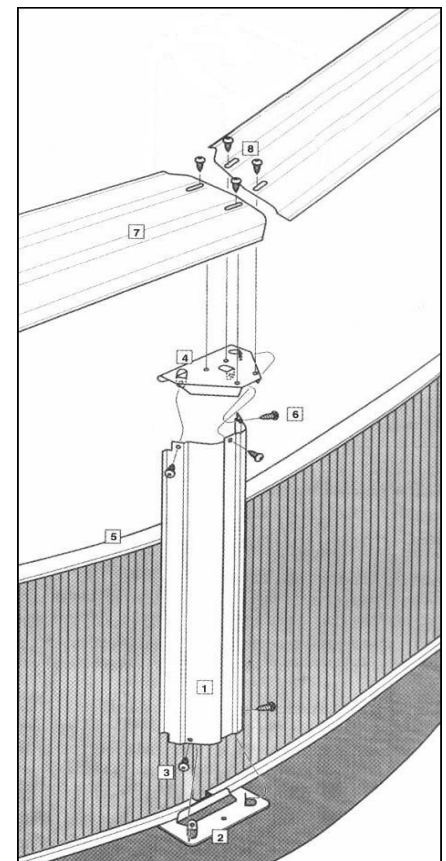

Fig.25

INSTALLATION OF TOP PROFILES (HOR)

Place a top profile (fig.25-26) with one end on top of the top plate. The side of the

top profile facing the centre of the pool should be close to the pool liner and pool wall. The side of the top profile facing the outside of the pool will form a large overhang.

Line up the holes as shown. Fasten through the two oval holes to the top plate below with two self-tapping screws (fig.26). Do not tighten the screws yet. Leave the screws slightly loose until all the top profiles are in place.

Repeat the last two steps for the other end of the top profiles. Repeat previous steps to install the rest of the top profiles around the top of the pool wall. Make the pool settle into a perfect circle by pushing the top of the pool wall vigorously inward at each vertical (this will help make the bottom of the pool wall shift into a perfect circle).

Adjust all the top profiles so they line up evenly with each other and tighten all the screws.

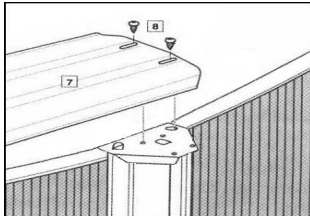

Fig.26

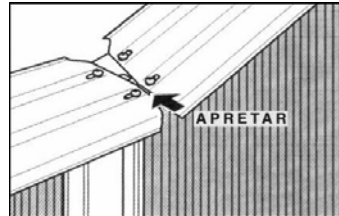

Fig.27



Fig. 28



Fig. 29

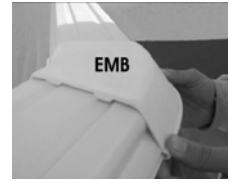

Fig.30

INSTALLATION OF THE TOP CONNECTORS (EMB)

Line up a one-piece top connector above the ends of two top profiles.
Hook the top connector under the inside edges of the top profiles (fig.28-29-30).
Bring the top connector down into place and pull out the front tabs to hook it under the outside edges of the top profiles.
Repeat the last three steps for the rest of the top connectors.

9. LAST DETAILS

Assemble the ladder as per its "assembly instructions", and put it in a place where the entrance/exit of the swimming pool will be set. It must be visible and, after bathing time, take the ladder out of the pool for safety reasons. The warning sticker must be in a visible place (i.e. close to the ladder).

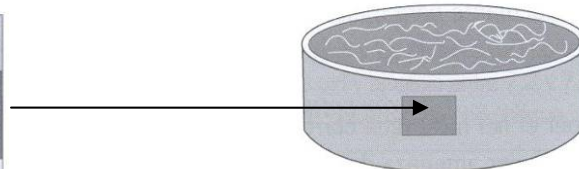

10. INSTALLING THE RETURN VALVE

Mark the holes on the liner (L) WITH A FELT PEN. By using a sharp blade, cut an "X" on the liner covering the holes, while holding the liner against the wall. The "X" should not exceed the size of the holes.

Cover the connection threading with teflon/ptfe tape.

Place the rubber washer (B) on the directable inlet (A) and place it into the hole on the inside of the pool. From the inside to the outside, cut the piece of the liner that exceeds on the outside.

Place the carton washer on the outside of the pool and while holding the connection from the inside, tighten the by threading (D) the large nut. Introduce the filter hose (E) and fix it with a clamp (H). Repeat this operation for the second connection. Make sure that the liner is free of wrinkles.

For more efficient filtration, we advise to direct the water jet. For this purpose, loosen the clamp (AR).

Move the directionable ball towards one of the sides of the swimming pool and slightly to the top and tighten the clamp again. In this way, the impurities will be directed towards the skimmer.

IMPORTANT: To avoid leaks, re-tighten the nuts after 48 hours.

- (A) – Steerable grid
- (BO)– Rubber washer

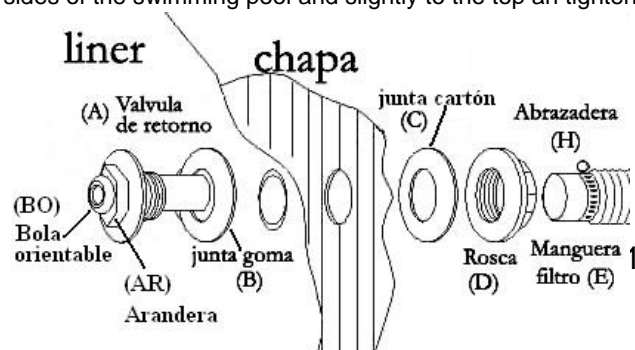

- (C) – Carton washer
- (H) – Clamp
- (E) – Filter hose
- (D) – Threaded Nut

(Inside)

(Outside the pool)

11. INSTALLING THE SKIMMER

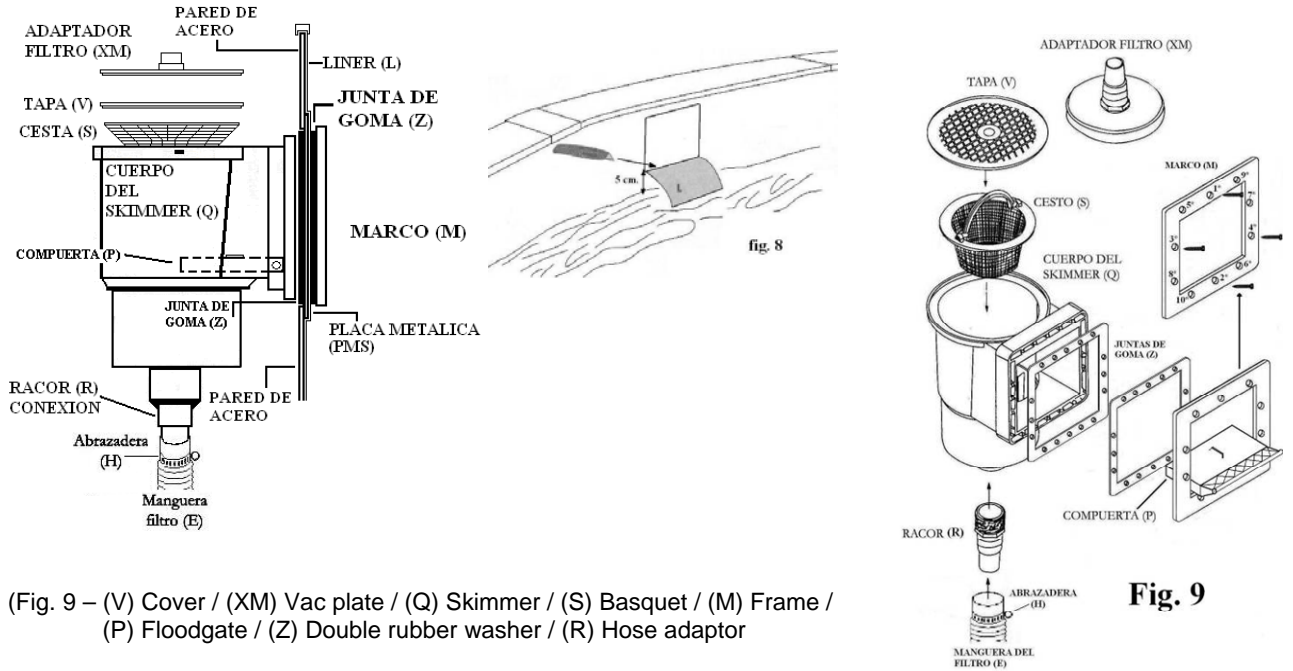

(Fig. 9 – (V) Cover / (XM) Vac plate / (Q) Skimmer / (S) Basquet / (M) Frame / (P) Floodgate / (Z) Double rubber washer / (R) Hose adaptor

Keep filling the swimming pool with water until 5 cm below the skimmer hole. With a felt pen mark the liner, the square hole for the installation of the skimmer and cut with a sharp blade the piece of liner marked. Place the double rubber washer (Z) on the steel wall. The steel wall and liner must go inside the grooves of the washer. Consecutively, install the skimmer frame with the screws. Make sure that all the holes are lined up (washer and skimmer). Fix the holes with the screws one after the other, but do not screw them up too much until a perfect matching is assured. Start screwing and finally tighten the screws firmly following the same order.

Cover the coupling (R) thread with teflon tape and screw up firmly into the skimmer. Fix one hose end on the coupling (R) with a clamp (H). Connect the other hose end to the filter water inlet and tighten with a clamp.

It's important to use teflon for all threads so as to assure a good seal. Install the floodgate (P) with a screwdriver. Finally, place the basket (S) inside the skimmer and the lid (V) on it.

CONNECTING A VACUUM CLEANER TO YOUR SKIMMER

For filters with a capacity of 6 m³/h minimum. Install the vac plate (XM) on the basket (S) inside the skimmer (Q). Connect one hose end to this adapter and the other end to the vacuum cleaner (or robot, if your filter capacity allows this). Connect the vacuum cleaner to a pole.

Fill the swimming pool up until at the halfway of the flood gate of the skimmer. So, the water will go inside the skimmer and fill the filtering system.

12. SWIMMING POOL MAINTENANCE

- WATER MAINTENANCE

All swimming pools need chemical treatment to maintain the water disinfected and crystal clear. Consult your chemical products supplier to determine those that are best for your needs. Water treatment procedure is not the same in all regions, because it depends on the water quality in each region.

WARNING: An incorrect treatment may cause water pollution that produces infections, poisonings and diseases.

The best water quality is obtained by using the right preventive treatment. To prevent the growth of algae and bacteria, use bactericide, algaecide, water pH correctors and flocculants (except for cartridge filters). Apply the first chlorine treatment within 24 hours of filling the pool.

Never add chemical products directly to the water. Chemicals must be diluted before being introduced into the water. Otherwise, the liner could be damaged. However, it is easier to keep the water clean than to clean contaminated water. Use your filter frequently.

Water maintenance is the most important factor in making your pool liner look excellent and last for a long time. Therefore, follow the instructions in the filter manual. The filter capacity must be high enough to filter the water of the pool at least 1 time in every 24 hours. The filter must be connected when there is nobody in the pool.

Make sure to check the water at least once a week, to keep the pool in optimum conditions.

Make sure that you do the following on frequent basis:

- Analyze the water pH and make sure it is between 7.2 and 7.6.
- Analyze the chlorine level and make sure it is between 0.5 and 2 grams per cubic meter.
- Remove any leaves and insects from the water.

Make sure that you do the following on weekly basis:

- Add the correct "maintenance quantity" of algaecide.
- Add anticalcareous if lime is formed or the water is hard.
- Use flocculants to improve filtering (except when using a cartridge filter).

- HANDLING CHEMICAL PRODUCTS AND SAFETY MEASURES

The following precautions must be taken when handling chemical products:

- Use gloves to protect your hands and masks or goggles for eye protection.
- No smoking where the products are stored or used. Many products are flammable.
- Wash your hands and face after using the products.
- Store the products in a dark and dry place. Do not leave the products in the sun.
- Make sure that the containers are closed. Tighten their caps or lids.
- Do not leave the products within the reach of children. Make sure that the products are stored in a high and safe place.
- Do not reuse the empty containers.
- Keep the products in their original containers.
- Do not remove the labels from the containers.
- Make sure that the storage area for chemical products has proper ventilation.
- When raining, increase the level of chlor and antialgae-bactericide.
- When adding water in the pool, check again the chlor and antialgae-bactericide level.
- Well ventilate the place where the chemical products are stored.

- POOL MAINTENANCE

After your pool has been completely installed, follow these instructions to keep it clean and in good condition.

- Liner – Regularly check for leaks in the liner. Use a repair kit for small repairs on the liner.
- Pool wall – Keep it clean, using a neutral soap. Do not use abrasives, chemicals or cleaning solutions. Clean up spilt chemical products, used for water treatment, right away. Coat all showing screw heads with clear outdoor varnish. Check the metal parts for rust, at least once a year. Coat all scratches and rusted areas with an anti-rust paint. Follow the instructions for paint application. At the end of the season, drain the water until the water level is 30 cm. Remove the upper part of the liner and check for possible rust on the inner side of the pool wall. Pay special attention to leaks in the filter and outlet holes. Leaks must be repaired right away.

Shock chlorination

It destroys quickly and efficiently micro-organisms, bacteria and fungi, if the chlorine level is raised up to 20 ppm approx.

Shock chlorination is recommended in the following cases:

- a) At the beginning of bath season.
- b) Depending on special climatic conditions (storms, rain...).
- c) In case of intensive use of the swimming pool.

Cleaning the bottom of the swimming pool by aspirating: only for pools with skimmer and filter with engines 6, 8, 10 y 15 m³. Connect the end of the hose to the brush and immerse it in the water for the hose to get filled up. Connect the other end of the hose to the aspiration cover and put it on the basket of the skimmer. Start the filter system in "drain off" and start cleaning the bottom.

Cleaning the bottom of the pool with a ventury: Connect a hose to the head of the ventury and immerse it in the swimming pool. Open the tap with a normal pressure and the ventury will start working. The water bounces on the ground producing an updraft that collects and deposits the dirt inside the filter-bag.

Problems	Causes	Solutions
Turbid water	Poor filtration. High pH. Excess of organic residues.	To do a counterwash of the filter. Add flocculating agent with a clarifier. Do a shock chlorination, except in cartridge filters.
Green water	Algae formation.	Brush the bottom and the pool's wall. Analyse pH and adjust between 7,2 and 7,6. Make a shock chlorination and add extra anti-algae.
Brown water	Presence of iron and manganese.	Analyse pH and adjust between 7,2 and 7,6. Do a shock chlorination
Inlays	Calcic of the water.	Analyse pH and adjust between 7,2 y 7,6. Add anti-calcareous once a week.
Eyes and skin irritation	pH disarranged. Excess of organic residues.	Analyse pH and adjust between 7,2 y 7,6. Make a shock chlorination.

13. CARE DURING WINTER MONTHS

If the pool is not disassembled during the winter, please follow these instructions at the end of the season, to prepare your swimming pool for the winter. During winterising, do not drain all the water. Never leave a swimming pool dry outside. Decrease the water level to just below (approx 15cms+) the skimmer opening. Cover the pool with a cover. To keep the cover flat, place an inflatable object or floater between the water and the cover. This way, the liner is not damaged by rain and/or freezing. You can also add a chemical product to the water in order to protect the liner against freezing. This product also facilitates the cleaning of the liner after the winter time.

To avoid that the water freezing, let several empty plastic bottles (or balls made of Porespan) float on the water. In case of snow, remove the snow of the cover regularly so as to avoid extra weight on the cover.

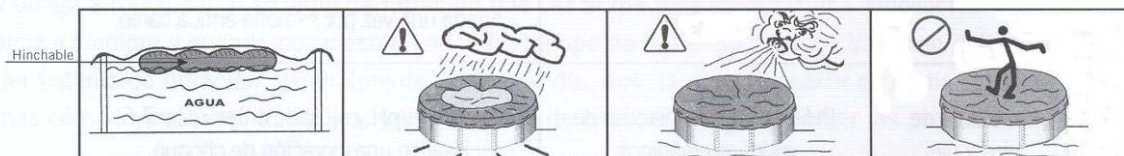

- Check all points and screws and that all joints are correctly adjusted. Check that the pool wall has not come out of the lower profiles. Check the screws are tight.
- Check rusted areas and paint all scratches or rusted areas using anti-rust paint.
- Check liner. Check that the upper part of the liner is still joined to the pool wall with plastic copings. DO NOT remove the pool liner. Removal of the liner shall void the product warranty and/or guarantee.
- Find any leaks. Check that there are no leaks in the liner. Leaks can cause great damage to your pool during the winter.

- Pool accessories. Remove all accessories, including the ladder, from the pool. Wash the ladder with water and neutral soap. Wash the rest of the accessories with water and neutral soap.
- Filter. Remove the filter from the pool. Wash the whole filter with water and neutral soap. Read the filter installation and maintenance manual.

14. TO EMPTY, DISASSEMBLE AND STORE YOUR POOL:

First check the filter instructions to make sure that your filter has the “option for emptying”. Use “the communicating vessels principle”: first completely submerge a hose in the pool until it’s full of water, then, cover one end with your finger and take it out of the pool. Water will start to come out. Make sure to keep the other end of the hose submerged to empty the pool.

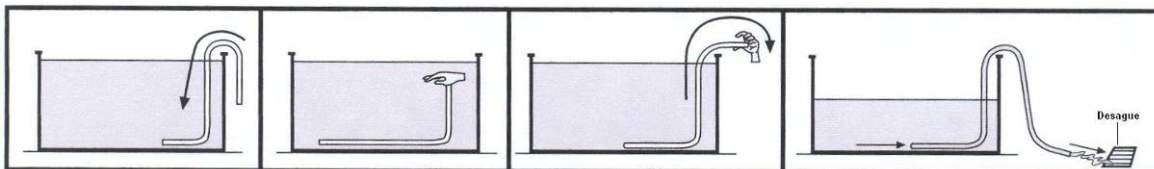

CAUTION: Keep account the amount of water you are going to empty in order to avoid unnecessary surplus water on the site. Keep a check all the time that the water flow out of the pool is running properly to waste. Otherwise, the excess of water could cause damage to people as well as material damage.

Always keep in mind the amount of water that will be drained in order to avoid any problem. It’s useful to have a drain close.

After all the water is drained, carefully disassemble the pool. In order to avoid any damage, deformation or tear, disassemble the parts in the reverse order to the installation. Check all the parts to make sure that they are perfectly clean and dry before storage.

Prior to storing, wash the liner with water and neutral soap that does not contain any chemical products. To conserve the liner in optimum condition and avoid bad odours and humidity, wipe the liner on both sides and dry it with a cloth or paper towel.

Make sure the liner is not pierced, fold and store it in a separate place. Keep the pool sections and parts of the pool in a dry and covered place. If any of the pool elements are damaged, replace them as soon as possible with original accessories. Please contact your supplier.

ASSEMBLED POOL START UP

Starting up the pool at the beginning of the season. The proper procedure must be followed to avoid problems during the period of the year that the pool is used. Check that your pool equipment (filter, skimmer, cartridges) are in good condition and work correctly.

If necessary, drain the pool and wash the liner with water and neutral soap. The liner must be cleaned when the sun is low. Maintain the walls and floor wet. Leave the product for a while and then rinse with water.

When the liner is completely clean, fill up the pool. Begin the chlorination treatment. If it takes more than a day to fill up the pool, add the chlorine gradually throughout this time.

To maintain the water in optimum condition, analyze the water pH and make sure it is between 7.2 and 7.6.

To reassemble your pool, follow the instructions beginning from the “INSTALLATION” section.

For further information please contact: -

Crystalclear Enterprises
Hamilton Lodge
58 Queens Road
Chadderton
Oldham
Tel. 0161 345 1110

E-Mail: sales@cheshireluxurypools.co.uk
www.cheshireluxurypools.co.uk

