



**Crystalclear Enterprises
Hamilton Lodge
58 Queens Road
Chadderton
Oldham
Tel. 0161 345 1110
E-Mail:**

**sales@cheshireluxurypools.co.uk
www.cheshireluxurypools.co.uk**

Please ask us for further information regarding up-grading your: -
Plumbing, Heating, water
sanitisation systems and all your
pool needs.

ASSEMBLY INSTRUCTIONS



ABOVE GROUND POOL SERIE NATIVA

ATTENTION

READ THESE INSTRUCTIONS CAREFULLY BEFORE PROCEEDING TO ASSEMBLE YOUR SWIMMING POOL. REMIND ALL POOL USERS THAT THESE SAFETY INSTRUCTIONS MUST ALWAYS BE FOLLOWED-UP. KEEP THESE INSTRUCTIONS FOR FUTURE CONSULTATIONS.

SAFETY GUIDELINES

- Remember that safety is the most important factor when installing the swimming pool. Safety must be given priority over any decorative aspect. Do not lean, jump, sit, stand or walk on profiles. They have not been designed to that effect.
- Do not dive or jump headfirst in you swimming pool, do not jump from a ladder or elsewhere. This pool is not deep enough to dive without risk of accident. The self-adhesive sign “Unsupervised, your child is in danger” must be placed close to or on your pool. For replacement adhesives, please contact our factory.
- Do not use your swimming pool when being under the effects of alcohol, medicines or drugs.
- To avoid drowning and injuries, do not leave tables, chairs or other objects near the swimming pool to prevent children from climbing into the pool.
- Do not install a slide on your swimming pool.
- To avoid electrocution risk, do not manipulate electrical equipment near to your swimming pool or with a wet body. Make sure that all electrical equipments is protected by a grounded switch.
- When bathing, never use metallic or punching footwear.
- If your pool has a cover on, do not allow anybody, and especially small children, to walk or play on it.
- Assign one entrance and exit for your swimming pool. This area must be kept totally clean. Remove all objects that could hurt barefooted people.
- Do not make holes in your swimming pool wall to install lights or any other devices. It could result in serious injuries, inundation, electrocution or property damage.
- For more security, we recommend to install a 122cm high fence or wall around your swimming pool made of a resistant material. All access doors/gates should have a lock installed at least at 122 cm high in order to prevent small children from opening them. If doors, windows and garden gates make part of the fence, make sure that they can be closed with a key or bolt.
- Do not use your swimming pool at night or when visibility is not good. The water of your swimming pool should be kept clean always in order to see the bottom and appreciate its depth. Users should be capable to see that the pool is not deep enough to dive. If you decide not to take into account this safety instruction, then it is your responsibility to provide users the appropriate instructions on the correct use of this product and supply sufficient light. For lightning recommendations, consult your local licensed electrical contractor on the appropriate light so as to fulfil all local and national norms of electricity and other security requirements.
- If your swimming pool is equipped with a ladder, than follow-up all safety guidelines and assembly instructions indicated in the manual.
- A ladder must be used to get in and out of the swimming pool. When not in use, the ladder should always be removed and kept in an inaccessible place.
- In order to maintain its stability, the ladder should be placed on a solid, leveled base at all times. Only one person at the time should be on the ladder
- Install the ladder where the entrance/exit of your swimming pool will be.
- Never use your ladder for other aims. The pool ladder has not been developed for other applications.
- If your swimming pool is equipped with a filter, make sure that the swimming pool is filled with water and your filter correctly connected as indicated in the manual,

- During the bathing season, the filter must work every day, long enough to renew all the water at least one time.
- Verify all parts of your pool on a frequent basis in order to detect possible failures and make sure all components are installed correctly. Always replace components with original **TOI** spare parts.
- This swimming pool has been designed for private use only. Do not use for commercial activities.
- Your children's safety depends on you! Risk is high when children's age is under 5 years! Accidents not only happen to other people! Avoid accidents and be prepared to react in case they occur!

WARNING: Every filter systems are up to the installation standard NF C15-100, which stipulate that every electrical appliance located less than 3,50m from the pool and easily accessible, have to be fed with very low voltage 12V. Every electrical appliance fed in 220 V, has to be located at least at 3,50m from the edge of the pool. Ask the manufacturer advice for any modification of one or several elements of the filter system.

Supervise and act:

- never leave a child alone and unsupervised
- assign one person to be responsible for the users' safety.
- increase supervision according to the number of pool users.
- supply inflatables to those who do not know how to swim
- teach your children how to swim as early as possible.
- wet your neck, arms and legs before going inside the water.
- learn first aid techniques, especially those of application to children.
- do not allow diving and jumping.
- do not allow sprints or violent games near or inside your swimming pool.
- children that cannot swim should not be allowed to enter the swimming pool without life jacket and without the company of an expert swimmer.
- do not leave toys inside or near the swimming pool.
- keep water clean and healthy permanently.
- store chemicals for water treatment out of children's reach;

Keep:

- your telephone close to the swimming pool in order not to interrupt supervision.
- inflatables and pole near the pool.

In addition, we recommend following equipment:

- manual or automatic cover, correctly installed.
- electronic device detecting passers-by and persons falling in the swimming pool.
under no circumstances, these additional equipment will substitute constant supervision.

In case of accident:

- take child out of the water as quickly as possible.
- call for help immediately and follow the instructions given.
- replace wet garments by hot and dry ones.

Memorize and keep first aid telephone number close to the pool:

- fire brigade
- ambulance, doctor, ...

Non-compliance with the safety guidelines and maintenance procedure can be harmful to health, especially for children.

DETERMINING THE INSTALLATION SITE FOR THE SWIMMING POOL

Take a look at your property to decide the ideal and the best site for the swimming pool.

The ground:

A large area is ideal. However, if a flat area, large enough for the swimming pool is not available, then choose an area where minimum digging is required.

Under no circumstances, the swimming pool must be installed below ground level. This swimming pool must only be installed above ground and on a hard, solid ground. The swimming pool must be installed near a drain or sewage system to avoid flooding in case of breakage / leakage.

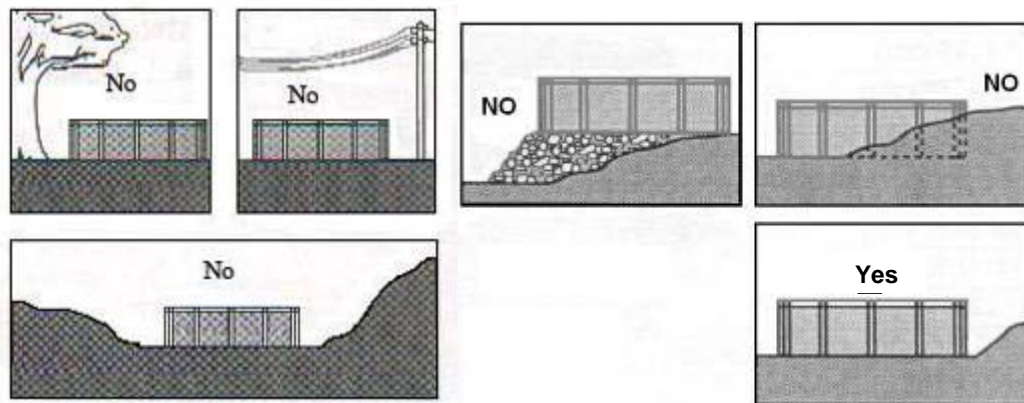

The swimming pool must be installed on a 100% plain and flat surface. Failure to observe this important safety measure can cause damage and deformation to the liner and / or the wooden structure, resulting in injuries to those who are near the swimming pool.

Never install this swimming pool inside a garage, or on a balcony, roof, terrace or any other surface that is not completely flat and solid. The maximum weight that the installation site can support must be taken into consideration.

Remove roots, grass and stones in the selected area, including those under the ground. The weight of the water will compress these elements between the liner and the earth under the swimming pool, resulting in damages. Grass left underneath the pool liner will rot and give of an unpleasant odor and stones and roots will damage the pool liner.

Avoid installing your swimming pool on fertilized ground or on any ground that has recently been treated with oil-based weed killers, chemicals or fertilizers. Avoid those areas where grass grows; it could go through the liner of your swimming pool.

Do not install your swimming pool on: marshland, tar, gravel and wood. A foundation made of leveled, solid and very compact soil / earth is the best base for your swimming pool. Do not install your swimming pool on a fragile earth or on a site that will not support the weight of the pool

Do not install your pool too close to your house, but in order to ensure maximum safety, install it where it can be readily seen and watched from the house.

Electric wires:

The swimming pool must be installed at a minimum distance of 6 meters from any electrical socket. To ensure maximum safety, it should never be installed directly below high voltage or medium voltage overhead electricity wires. In some communities, it is illegal to do so.

Underground cables:

Check for any buried electrical, telephone cables, or gas pipes at the site before you start digging to level the surface.

Trees:

Overhanging trees and their tenants (birds, insects...) are not the swimming pools' best friends. The resin and falling leaves and twigs can cause problems in maintaining your swimming pool's water clean. If there is a filtering system, it will have to be used more often. Install the swimming pool away from the trees.

Grounded sockets:

In the case where the swimming pool has or uses a water filter or any other electrical device, and there is no grounded socket nearby, you must have one installed by an authorized electrical technician.

TOOLS REQUIRED: (not included)

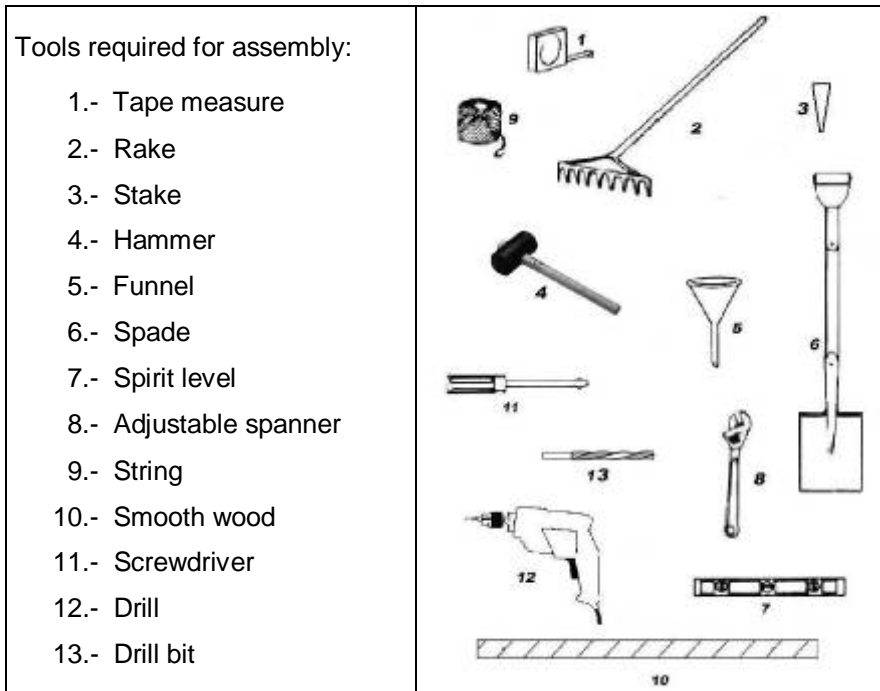

PRECAUTIONS FOR CORRECT STORAGE

The wooden swimming pool is manufactured using natural, living hardwood material. The composition and characteristics of this material must be borne in mind and basic precautionary measures employed to ensure greatest satisfaction.

Slight warping (concave wood, or convex lengthwise) will not cause problems for assembly. Fissures and small cracks that can occur during drying are normal phenomena that do not cause problems for assembly and do not affect the guarantee.

Before the pool is assembled, it is sensitive to temperature changes. Take the following precautions on receipt of the pool kit:

If you do NOT assemble the kit straightaway:

- Store the pool kit on a flat surface, in a ventilated area not subject to major temperature and humidity variations.
- The best way to store the kit is with a weight on top of it, which ensures that none of the components will buckle.

If you assemble the kit straightaway:

- Remove the strapping, taking care to step away when cutting in case the strapping springs off quickly.
- Assemble the kit within a maximum of 24 hours.
- Do not assemble the pool kit in gapped stages, or in high temperatures, and do not leave the wood exposed to sunlight.
- Use the correct tools.

INSTALLATION

Do not install the swimming pool on a windy day. It is extremely difficult to keep the swimming pool wall upright and it would probably fall, resulting in injuries.

Always place a protective sheet under the liner in order to avoid wear and tear caused by rubbing against the ground and the weight of the water.

It is possible to level the ground in two ways:

1st possibility: Prepare a concrete platform. The platform should have the same size as the pool diameter plus 30cm.

2nd possibility: Level the ground yourself:





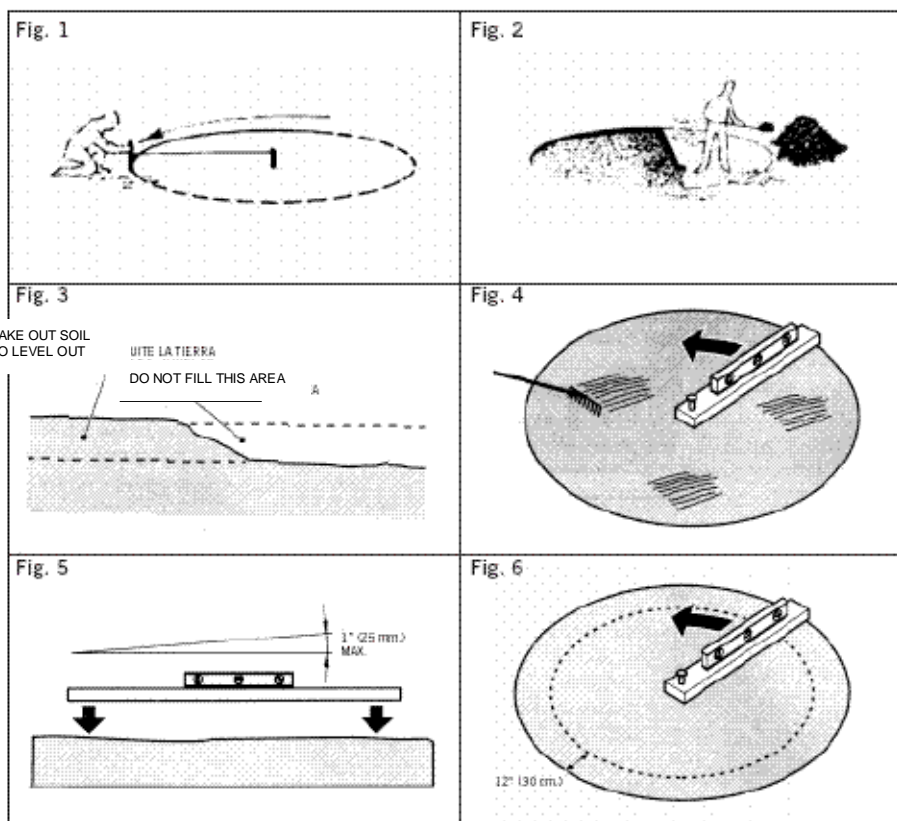





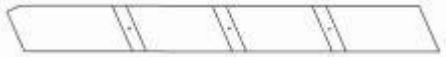





- a) Hammer a peg into the ground in the center of the area where you want your pool. Tie a string equal to the length of the radius of the swimming pool to the peg and mark a circle (fig. 1).
- b) Level the ground in the marked area. The entire area of the swimming pool must be leveled and free of stones and twigs. Locate the lowest point within the circle. Using a leveling tool and a straight wooden board, level the surface down to the level of the lowest point. Do not fill in the holes; dig away higher areas (fig. 2, 3 and 4). Scatter a fine layer of sifted sand over the levelled surface and level again.
- c) Expand a thin layer of sifted sand about 5cm high on the surface of the pool base. Level again. Instead of sand you can also use sheets of polyethylene between 25 and 28mm thick.







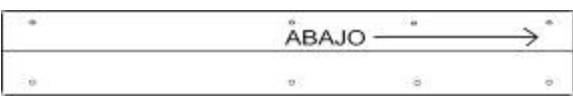







In all cases, we recommend you place on the floor a ground floor



LIST OF COMPONENTS IN WOODEN POOL KIT

COMPONENTS: Take out and organise the pool components before starting assembly.

COMPONENTS OF WOODEN POOL KIT		Ø 240	Ø 350	Ø 450	Ø 550
	Steps frame (PTESC)	2	2	2	2
	Step rungs (PESC)	3	3	3	3
	Plain batten (B)	28	43	58	68
	Lower batten (A)	6	9	12	14
	Batten with mounting holes (C)	12	18	24	28
	Upper batten (D)	5	8	11	13
	Skimmer upper batten (F)	1	1	1	1
	Skimmer/valve batten (E)	1	1	1	1
	Valve batten (G)	1	1	1	1
	External section (PEN)	6	9	12	14
	internal section (PIN)	6	9	12	14
	Corner (CAN)	6	9	12	14
	Supports (AP)	6	9	12	14
	Skimmer metal plate (PMS)	1	1	1	1
	Backflow valve plate (PVR)	1	1	1	1
	External metal angle (AEN)	6	9	12	14
	Internal metal angle (AIN)	6	9	12	14
	Bracket (ES)	12	18	24	28

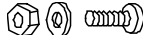
	Skimmer (SK)	1	1	1	1
	Tips 8 Ø	48	72	-----	-----
	Tips 10 Ø	-----	-----	96	112
	Couch screw support 4x65	12	18	24	28
	Couch screw section (PIN) 6x50	12	18	24	28
	Ladder screw 6x70	16	16	16	16
	Metal corners screw 4x20	56	80	104	120
	Hinge screw 3x15	8	8	8	8
	Hinge	2	2	2	2
	Srew M8x45 (TO)	36	54	-----	-----
	Srew M10x45 (TO)	-----	-----	72	84
	Srew M8x50 (TO2)	12	18	-----	-----
	Srew M10x50 (TO2)	-----	-----	24	28
	Nuts M8	48	72	-----	-----
	Nuts M10	-----	-----	96	112
	Washer M8	48	72	-----	-----
	Washer M10	-----	-----	96	112
	Liner	1	1	1	1
 + 	Steel wall + strip of PVC			1	1
	Screws to fix the steel wall			16	16

ASSEMBLY OF WOODEN WALLS

This wood has been subjected to an autoclave protective treatment using organic solvents and contains biocides, insecticides and fungicides to protect the wood from possible damage caused by burrowing insects and fungi.

It also has anti-woodworm and anti-termite properties.

Wood treated in this way is not hazardous as it is non-toxic for humans, animals and plants.



photo 1

The pool kit is packed in such a way that it is not necessary to unpack all the battens from the pallet to start assembling the pool, since the components stacked at the top of the pallet are those corresponding to the pool base, photo 1. For safety reasons, we recommend that two or more people assemble the pool.

Very important: use gloves during assembly to prevent any possible accidents.

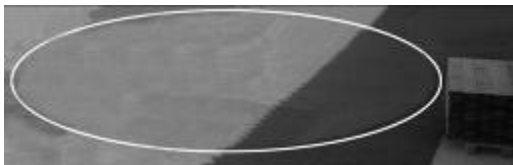

photo 2



photo 3

- a) On correctly levelled ground, make a circle matching the dimensions of your pool with sand, flour, plaster and chalk. Place the battens (A) on top of the circle (240 Ø 6 battens A; 350 Ø - 9 battens A; 450 Ø – 12 battens A; 550 Ø – 14 battens A), photos 2, 3.

Once you have laid the battens, place the external metal sections (AEN) around the outside of the circle and the internal metal sections (AIN) around the inside of the circle, laying them flat in the ground, photo 4. Distribute screws, washers and nuts, photo 5. Lift the battens up, photo 6.



photo 4

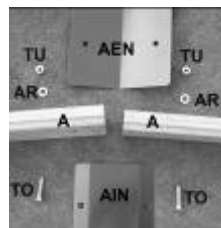

photo 5

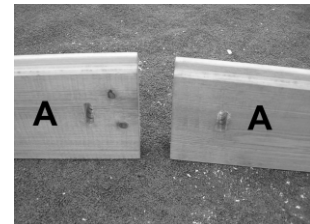

photo 6

- b) Have someone help you lift the metal sections into the vertical position, the part with most holes at the bottom (AEN, AIN) and join them together using the screws (TO) so that the screw head is on the inside of the pool, fit the washer (AR) and the nut (TU), tighten by hand (later on during assembly you will tighten them properly). Repeat this process for each of the pool angles. Important: As you close the circle, you will need help to keep the sections in the vertical position and prevent them from falling down.





Insert screw (TO)
Tighten nut

Fit washer (AR)

Fit nut (TU)

angle to angle. (photo



Once you have put all the metal sections in place, check the diameter of the pool by measuring from 7).

photo



7

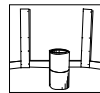

photo 8

PUTTING THE WALLS IN

foto 9

PLACE



Only for models 550 and 460: place the steel wall inside the pool before installing the wooden battens.



foto 10

Be very careful when inserting the battens, they must fit inside the metal sections and must all be centred and in line with each other, photo 8.

c) Place one level of battens (B) on top of battens (A), within the metal sections and for each wall section, carry on until reaching the second hole, photo 9 (use a rubber-headed mallet to tap the battens down snug to each other, very important; do not hit the battens directly), photo 10.

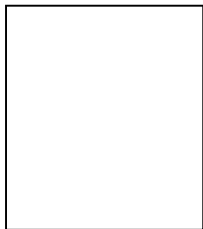

foto 11

d) Place battens (C) onto battens (B) within the metal sections. Insert the screws (TO) so that the screw head is on the inside of the pool, if they are difficult to insert then use the rubber-headed mallet to tap the battens and manipulate the metal sections backwards and forwards until the screws can be inserted, fit the washer (AR) and the nut (TU) and tighten by hand (later on during the assembly process you will tighten them properly), photo 11. Repeat this process for each of the pool sides. Use a spirit level to check that the metal sections (AIN) are level, photo 12 (check at least three sections).

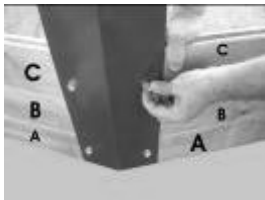

foto 12

e) Place a layer of battens (B) onto (C) and within the metal sections, repeat for each side of the pool (use a rubber-headed mallet to tap battens down snug every so often, do not hit battens directly).

f) Place a layer of battens (C) onto (B) within the metal sections, photo 13, insert the screws (TO) so that the screw head is on the inside of the pool, if they are difficult to insert then use the rubber-headed mallet to tap the battens and manipulate the metal sections backwards and forwards until the screws can be inserted, fit the washer (AR) and the nut (TU) and tighten by hand (later on during the assembly process you will tighten them properly). Repeat this process for each of the pool sides.



foto 13

Important: Choose one of the pool sides for the location of the backflow valve and skimmer battens, bearing in mind that this wall should be nearest to a piece of open land or a drain, etc. (See section BACKFLOW VALVE AND SKIMMER WALL).

g) For the remaining walls, place the battens (B) within the metal sections (use a rubber-headed mallet to tap the battens down snug with each other) (very important; do not hit the battens directly), to



foto 14

finish off, place battens (D), *this batten is smooth on its upper surface*, photo 14. Insert the screws (TO) so that the screw head is on the inside of the pool, if they are difficult to insert then use the rubber-headed mallet to tap the battens and manipulate the metal sections backwards and forwards until the screws can be inserted, fit the washer (AR) and the nut (TU) and tighten by hand (later on during the assembly process you will tighten them properly).

BACKFLOW VALVE AND SKIMMER WALL

Once you have decided which wall will hold the backflow valve and skimmer, place batten (B) on batten (C), then place valve batten (E), followed by valve-skimmer batten (F), then lastly batten (G), photo 8. Insert the screws (TO) so that the screw head is on the inside of the pool, if they are difficult to insert then use the rubber-headed mallet to tap the battens and manipulate the metal sections backwards and forwards until the screws can be inserted, fit the washer (AR) and the nut (TU). Important: Do not hit the battens directly.

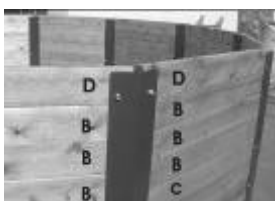
ASSEMBLY OF METAL BRACKET (ES)

Before installing the metal brackets, level the battens, as follow:

- check with a spirit level if the battens are perfectly levelled
- if not, beat carefully the battens with a rubber hammer until the battens are perfectly levelled.

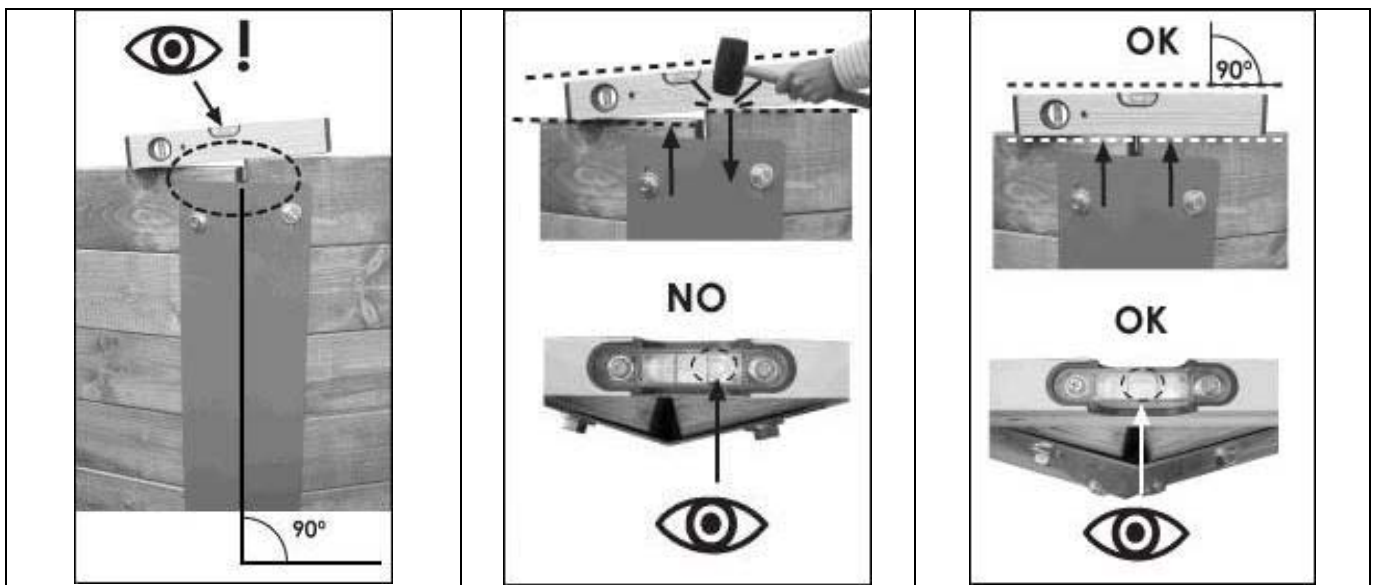

Loosen the nuts at the top, place the bracket between the metal section and the wood, lining up the screw with the groove in the bracket and let the bracket rest on the external metal section (AEN). Don't tighten the screws.



Loosen nut



Insert bracket



Partial view

ASSEMBLY OF SUPPORTS (AP)

Place the PIN section temporarily on top of the batten, photo 15, hold the support against the wall and flush with the PIN section, photo 16, attach the support with 4 x 65 mm screws, photo 17. Carry out this assembly for all the pool walls, including the skimmer wall.

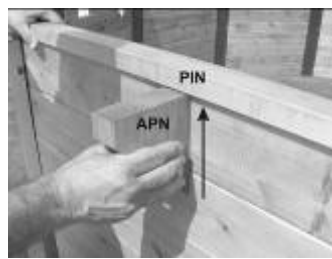
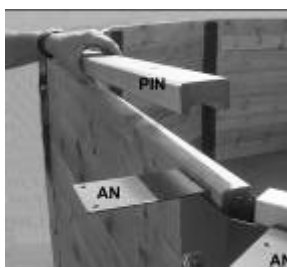
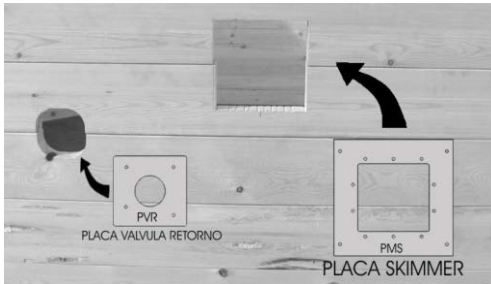

photo 15

photo 16

photo 17

ASSEMBLY OF BACKFLOW VALVE PLATE AND SKIMMER PLATE



picture 7

ASSEMBLY OF BACKFLOW VALVE PLATE (PVR)

To centre the backflow valve plate (on the inside of the pool), follow these steps:

- Temporarily place the backflow valve in the plate, photo 18.
- Place the backflow valve hole in the pool opening, photo 19.
- Centre the valve and mark the screw holes, photo 20.
- Remove the valve from the plate and screw the plate to the wall. (4 x 20 screws), photo 21.
- Cover the screw heads to prevent damage to the liner.



photo 18



photo 19



photo 20

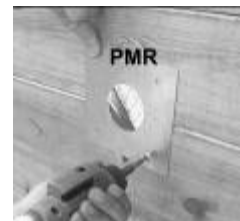

photo 21

ASSEMBLY OF SKIMMER PLATE (PMS)

To centre the skimmer plate (on the inside of the pool), follow these steps:

- Insert the skimmer inside the opening in the wall, photo 22, from the outside inwards.
- Screw in the skimmer plate temporarily.
- Centre the plate in the opening and mark the screw holes, photo 23.
- Remove the screws and the skimmer.
- Screw in the plate on the inside of the wall. (4 x 20 screws), photo 24.
- Cover the screw heads to prevent damage to the liner.



photo 22



photo 23



photo 24

INSTALLATION FOR INNER GALVANIZED STEEL WALL (ONLY FOR MODELS 460 AND 550)

VERY IMPORTANT: Do not bend or wrinkle the metal wall during installation, unroll it carefully. Place a cardboard under the metal wall to unroll it easily and prevent the wall to scratch and consequently get rusted.

Do not install the metal wall on a windy day. We suggest installing the metal wall between two adults.

Very Important: Wear gloves during assembly to prevent possible accidents with the metal edge.

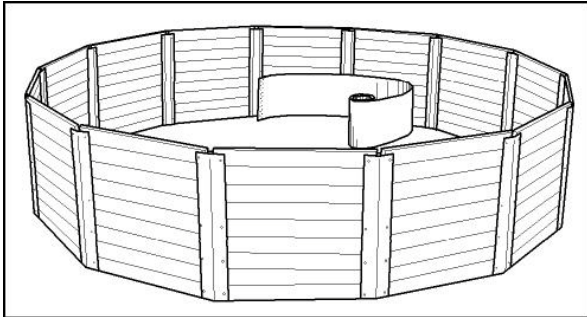

Fig. 1

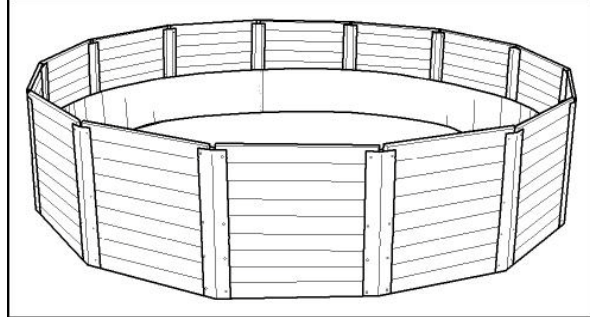

Fig. 2

Cut the strip of the steel wall and carefully unroll the inner wall of the pool given that the end of the band have to match one of the metal columns of the pool (Figure 1).

The galvanized wall has to be in direct contact with the wooden wall. If necessary help yourself with your foot to push the wall into the corner in order to leave as less space as possible between the wooden and the steel wall (Figure 2).

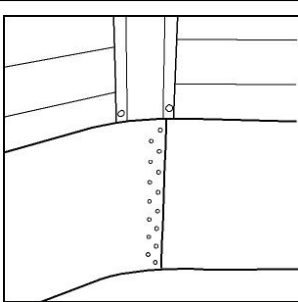

Fig. 3

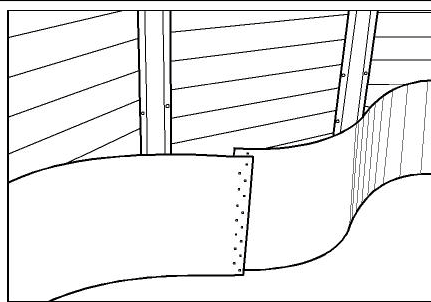

Fig. 4

When the steel wall will have been completely unrolled, check that the holes in the ends coincide with a metal column (Figure 3). The steel wall should be as closer as possible from the wooden wall.

To put the screws more easily, separate the ends of the band to the inside of the pool in order to leave a gap between the steel wall and the wooden wall where you can work (figure 4). **IMPORTANT:** Put all the screws in the holes and place the screw heads facing the inside of the pool and the nuts and washers out making them match the metal column to avoid breaking the liner.

Once bolted properly, protect the screw heads with the blue PVC strip, fix it properly with seal. (Figure 5)

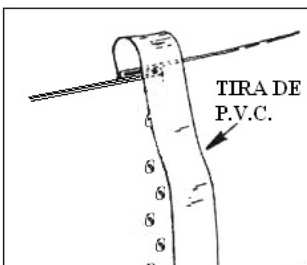
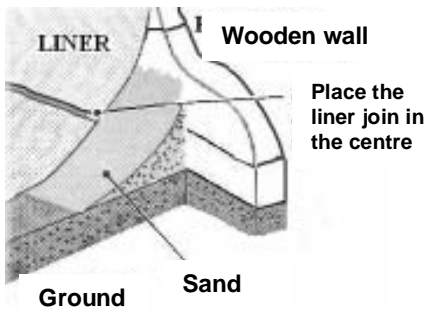

Fig. 5

INSTALLATION OF PVC LINER



picture 8

If you have decided to use sheets of polyethylene (see bottom of page 6), install them now. If not, cover the entire inner pool surface with about 5cm high of thin sifted sand. With the help of a rake properly level the floor.

IMPORTANT: Once the floor is leveled, add some more clean sifted sand in the inside bottom border. Press the sand into a vertical triangular shaped layer. The height of this triangular layer must be around 20 cm. (fig. 18). In this way, you will prevent the liner from sliding under the wall and being damaged due to the pressure and the weight of the water (picture 8).

The PVC used for our liners has been designed to withstand long periods of exposure to sunlight and UV rays. Under some climate and use conditions, its characteristics may vary slightly.

Do not walk on the liner wearing shoes, do not throw tools onto the liner, and do not place any sharp objects on the liner.

The liner is the most important and fragile component of the pool. Unpack it without using a knife or any other sharp tool and separate the liner from the rest of the components. Store it in a safe place where it is not likely to be punctured or damaged by tools.

Choose a sunny day to install the liner, when the temperature is at least 20°. The liner is manufactured from a vinyl based, highly flexible material and is designed to stretch during installation; this is why it must be warmed through when installed into your pool.

- Place the liner (L) in the centre of the pool and unfold outwards towards the sides (Place the rough side towards the inside of the pool), photo 25.
- Locate the welding side of the liner and place it so it is perfectly straight and perpendicular to the ground, this will help you place the side section with no wrinkles.
- Lift the side section and hook it onto the pool angles, fixing with clips so that it stays in place, photos 26, 27, 28.
- Remove the surplus of liner by pulling it carefully outwards, do not tug it sharply. It is important that the liner is properly centred, taut and with as few folds as possible. To remove folds from the liner on the base of the pool, take off your shoes and smooth the liner out towards the sides with your feet and hands while the pool is being filled photos 29, 30.
- As the pool is being filled pull little by little the liner to get it as tighter as possible. The water pressure will fix the liner to the wall. **FOR NOW ONLY FILL YOUR POOL HALF WAY.**



photo 25



photo 26



photo 27



photo 28



photo 29

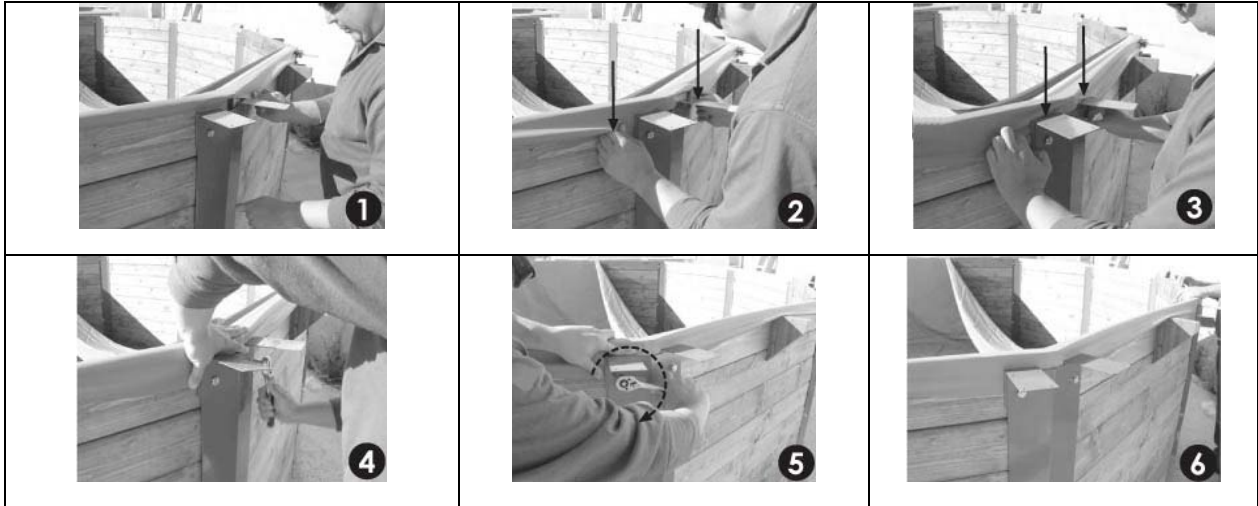

photo 30

ASSEMBLY OF THE INTERNAL SECTIONS (PIN), TIPS (CAN), EXTERNAL SECTIONS (PEN)

For a better liner adjustment, place the liner between the brackets (ES), as follow:

- 1) Stretch the liner and glide it between the metal angles and wood wall as shown in the three first following pictures.
- 2) Once we have the liner in place, hold it with your hand while you tight the nuts, repeat this operation for the all the angles (photos 4 and 5).
- 3) It is advisable to install the liner on a sunny day because the heat makes it more malleable.



- a) Centre the wooden tips (CAN) on the metal angles, photo 31.
- b) Place the internal wooden sections on either side of the tip, photo 32, leaving a gap of +/- 3 mm between the wooden section and the tip, photo 33.
- c) Place tips and wooden sections all around the pool, photo 34. Check that they are properly distributed.
- d) Using 5 x 50 screws, attach the wooden sections, photo 35, to all the pool sides.

Adjusting the tips (CAN)

- a) Remove the tip (CAN), photo 36. Make sure the wooden walls are levelled (see page 11). Move the metal angle upwards so it is flush with the wooden section, photo 37.
- b) Use an adjustable spanner to tighten the nut. Do this for all the pool's metal angles, photo 38.
- c) Put the tip back in place, photo 39.



photo 31

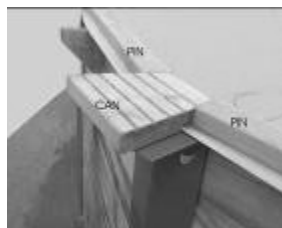

photo 32

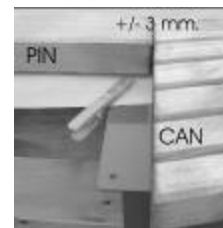

photo 33



photo 34



photo 35



photo 36



photo 37



photo 38



photo 39

Assembly of external wooden sections (PEN)

- Place the wooden sections (PEN) around the edge between the tips and adjust the distance to +/- 3 mm, photo 40.
- Using 4 x 20 screws, attach the sections from below the sections and tips, photos 41 and 42, except for the wooden section where the skimmer is (since the hinges will go on this section).

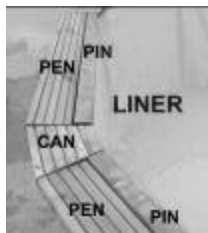

photo 40



photo 41



photo 42

ASSEMBLY OF TIPS

- Before fitting the tips, tighten all the nuts in the metal angles of the pool, photo 43.
- Fit tips to all the nuts, photos 44 and 45.



photo 43



photo 44



photo 45

ASSEMBLY OF HINGES IN THE EXTERNAL SECTION (PEN)

- Place the wooden section (PEN) on top of the internal section (PIN), photo 46.
- Place the hinge 15 cm in from each end of each section, situating it in the centre of the two sections, photo 47. Attach the hinge using the 3 x 15 screws.
- General view, photo 48.



photo 46

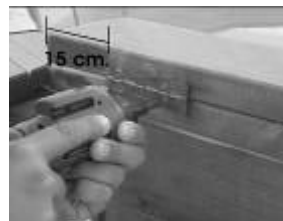

photo 47



photo 48

ASSEMBLY OF THE STEPS

- Place the rungs in the guides inside the step frame, photos 49 and 50.
- Attach the rungs with 6 x 70 screws, photo 51.
- Turn the steps and repeat a) and b), photos 52 and 53.
- Place the steps on the wall opposite the skimmer. You will need to place the top end of the steps under the wooden section (PEN). Make sure the steps are properly lined up in relation to the wall, photo 54.
- Using a 5 Ø drill bit, drill a hole in the external wooden section (PEN), making sure it is in line with the hole in the top end of the steps, photo 55.
- Use 6 x 70 screws to attach the steps to the wooden section (PEN), photo 56.

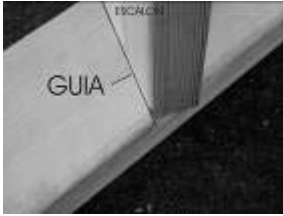

photo 49



photo 50



photo 51



photo 52



photo 53



photo 54



photo 55



photo 56

ASSEMBLY OF THE STAINLESS INNER LADDER

To install the stainless inner ladder to the wider upper wooden batten (special for the ladder) see the following instructions:

View of the special batten	Make holes - broach 10,5 Ø	Check holes
Put the screws 10 Ø	Up down view	Place the washers and nuts



FINISHING DETAILS

Be sure to attach the warning sticker where it is clearly visible, for example next to the steps (pictures 9 and 10).



picture 9

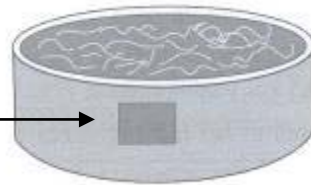

picture 10

INSTALLING THE RETURN VALVE

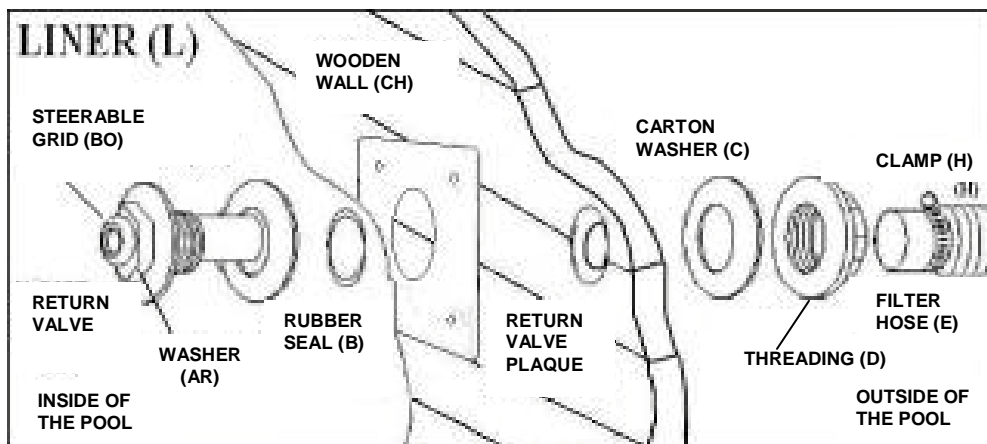

The return valve is located at the bottom of the pool wall, and water is returned to the pool through it after treatment in the filter.

- 1) Start pouring water into the pool and stop when it reaches 5 cm below the bottom of the valve hole. Mark the holes on the liner (L) with a felt pen. By using a sharp blade, cut an "X" on the liner covering the holes, while holding the liner against the wall. The "X" should not exceed the size of the holes.
- 2) Cover the connection threading with teflon.
- 3) Place the rubber washer (B) on the steerable grid (A) and place it into the hole on the inside of the pool. From the inside to the outside, cut the piece of liner that exceeds on the outside.
- 4) Place the carton washer (C) on the outside of the pool and while holding the connection from the inside, tighten the threading (D) of the large nut. Introduce the filter hose (E) and fix it with a clamp (H). Repeat this operation for the second connection. Make sure that the liner is free of wrinkles.

For a more efficient filtration, we advise to direct the water jet. For this purpose, loosen the clamp. Move the directionable ball towards one of the sides of the swimming pool and slightly to the top and tighten the clamp again. In this way, the impurities will be directed towards the skimmer.

IMPORTANT: To avoid leaks, re-tighten the nuts after 48 hours.

INSTALLING THE SKIMMER

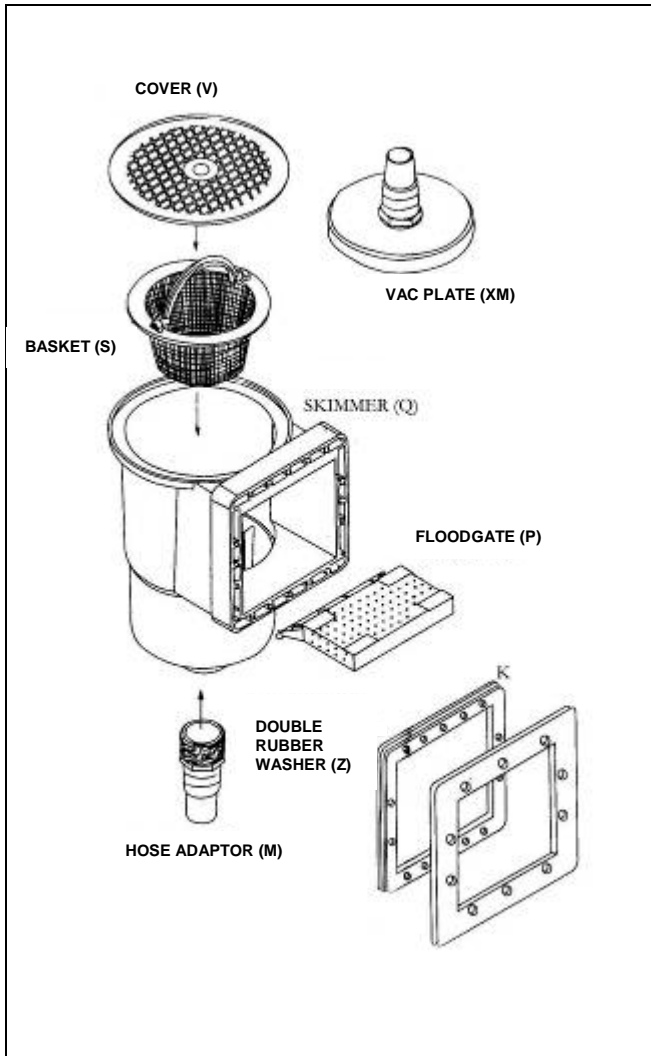

Keep on filling the swimming pool with water until 5 cm below the cutted skimmer hole. With a felt pen mark on the liner the square hole for the installation of the skimmer and cut with a sharp blade the piece of liner marked. Place the skimmer and one rubber "K" in the hole for the Skimmer (from out to down of the pool), then place the other rubber "K" inside the pool against the liner . Consecutively, install the skimmer frame with the screws. Make sure that all the holes are lined up (washer, die and skimmer). Fix the holes with the screws one after the other, but do not screw them up too much until a perfect matching is assured. Start screwing and finally tighten the screws firmly following the same order.

Cover the coupling (M) threading with teflon and screw up firmly into the skimmer. Fix one hose end on the coupling (M) with a clamp (H). Connect the other hose end to the filter water inlet and tighten with a clamp. It is important to use teflon for all threadings so as to assure total waterproofness. Install the floodgate (P) with a screwdriver.

Finally, place the basket (S) inside the skimmer and the cover (V) on it.

Then, finish filling your pool up to the $\frac{3}{4}$ of the Skimmer hole.

CONNECTING A VACUUM CLEANER TO YOUR SKIMMER

For filters with a capacity of 6m³/h minimum. Install the vac plate (XM) on the basket (S) inside the skimmer (Q). Connect one hose end to this adapter and the other end to the vacuum cleaner (or robot, if you filter capacity allows this). Connect the vacuum cleaner to a stick or a pole.

Fill the swimming pool until half the floodgate of the skimmer. So, the water will go inside the skimmer and fill the filtering system.

SWIMMING POOL MAINTENANCE

Water maintenance

All swimming pools need chemical treatment to maintain the water disinfected and crystal clear. Consult your chemical products supplier to determine those that are best for your needs. Water treatment procedure is not the same in all regions, because it depends on the water quality in each region.

The best water quality is obtained by using the right preventive treatment. To prevent the growth of algae and bacteria, use bactericide, algaecide, water pH correctors and flocculants (except for cartridge filters). Apply the first chlorine treatment within 24 hours of filling the pool.

Never add chemical products directly to the water. Chemicals must be diluted before being introduced into the water. Otherwise, the liner could be damaged.

However, it is easier to keep the water clean than to clean contaminated water. Use your filter frequently.

Water maintenance is the most important factor in making your pool liner look excellent and last for a long time. Therefore, follow the instructions in the filter manual. The filter capacity must be high enough to filter the water of the pool 3 times in every 24 hours. The filter must be connected when there is nobody in the pool.

Make sure to check the water at least once a week, to keep the pool in optimum conditions.

Make sure that you do the following on frequent basis:

- a) Analyze the water pH and make sure it is between 7.2 and 7.6.
- b) Analyze the chlorine level and make sure it is between 0.5 and 2 grams per cubic meter.
- c) Remove any leaves and insects from the water.

Make sure that you do the following on weekly basis:

- a) Add the correct 'maintenance quantity' of algaecide.
- b) Add anticalcareous if lime is formed or the water is hard.
- c) Use flocculants to improve filtering (except when using a cartridge filter).

Handling chemical products and safety measures.

The following precautions must be taken when handling chemical products:

- 1) Use gloves to protect your hands and masks or goggles for eye protection.
- 2) No smoking where the products are stored or used. Many products are flammable.
- 3) Wash your hands and face after using the products.
- 4) Store the products in a dark and dry place. Do not leave the products in the sun.
- 5) Make sure that the containers are closed. Tighten their caps or lids.
- 6) Do not leave the products within the reach of children. Make sure that the products are stored in a high and safe place.
- 7) Do not reuse the empty containers.
- 8) Keep the products in their original containers.
- 9) Do not remove the labels from the containers.
- 10) Make sure that the storage area for chemical products has proper ventilation.
- 11) When raining, increase the level of chlor and antialgae-bactericide
- 12) When adding water in the pool, check again the chlor and antialgae-bactericide level.
- 13) Well ventilate the place where the chemical products are stored.

Pool maintenance

After your pool has been completely installed, follow these instructions to keep it clean and in good condition.

1. Liner

- a. Regularly check for leaks in the liner.
- b. Use the repair kit for small repairs on the liner.

2. Pool wall

- a. Keep the pool wall clean. Clean the wall with a neutral soap. Do not use abrasives, chemicals or cleaning solutions.
- b. Clean up spilt chemical product, used for water treatment, right away.
- c. Coat all showing screw heads with clear outdoor varnish.
- d. Check the metal parts for rust, at least once a year.
- e. Coat all scratches and rusted areas with an anti-rust paint. Follow the instructions for paint application.
- f. At the end of the season, drain the water until the water level is 30 cm. Remove the upper part of the liner and check for possible rust on the inner side of the pool wall.
- g. Pay special attention to leaks in the filter and outlet holes. Leaks must be repaired right away.

Care during winter months

If the pool is not disassembled during the winter, compliment following instructions at the end of the season to prepare your swimming pool for the winter. During wintering, do not drain all the water. Never leave a swimming pool dry outside. Decrease the water level just below the skimmer opening. Cover the pool with a cover. To keep the cover flat, place an inflatable object or floater between the water and the cover. This way, the liner is not damaged by rain and / or freezing. You can also add a chemical product to the water in order to protect the liner against freezing. This product also facilitates the cleaning of the liner after the winter time. To avoid that the water starts freezing, let several empty plastic bottles (or balls made of Porespan) float on the water. In case of snow, remove the snow of the cover regularly so as to avoid extra weight on the cover.



1. Check all joints and screws.
 - a. Check that all joints are correctly adjusted. Check that the pool wall has not come out of the lower profiles.
 - b. Check that the screws are tight.
2. Check rusted areas
 - a. Paint all scratches or rusted areas using anti-rust paint.
3. Check liner
 - a. Check that the upper part of the liner is still joined to the pool wall with plastic copings. **DO NOT** remove the pool liner. Removal of the liner shall void the product warrantee and/or guaranty.
4. Find any leaks
 - a. Check that there are no leaks in the liner. Leaks can cause great damage to your pool during the winter.
5. Pool accessories
 - a. Remove all accessories, including the ladder, from the pool.
 - b. Wash the ladder with water and neutral soap.
 - c. Wash the rest of the accessories with water and neutral soap.
6. Filter
 - a. Remove the filter from the pool.
 - b. Wash the whole filter with water and neutral soap.
 - d. Read the filter installation and maintenance manual.

To empty, disassemble and store your pool:

First check the filter instructions to make sure that your filter has the 'option for emptying'.

Use 'the communicating vessels principle': first, completely submerge a hose in the pool until it is full of water, then, cover one end with your finger and take it out of the pool. Water will start to come out. Make sure to keep the other end of the hose submerged to empty the pool.

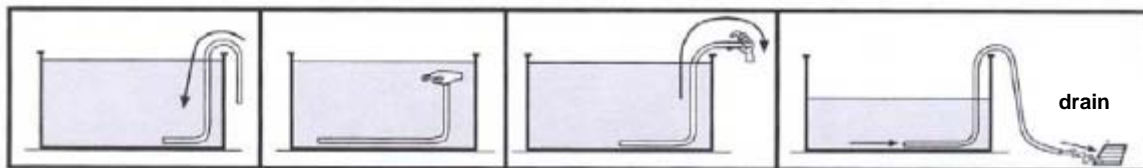

Caution: Keep into account the amount of water you are going to empty in order to avoid unnecessary surplus water on the site. Check at any time that the water flow out of the pool is properly evacuated. Otherwise, the excess of water could cause damage to people as well as material damage. It is useful to have a drain close.

After all the water is drained, carefully disassemble the pool. In order to avoid any damage, deformation or tear, disassemble the parts in the inverse order to the installation. Check all the parts to make sure that they are perfectly clean and dry before storage.

Prior to storing, wash the liner with water and neutral soap that does not contain any chemical products. To conserve the liner in optimum condition and avoid bad odors and humidity, wipe the liner on both sides and dry it with a cloth or paper towel.

To make sure that the liner is not pierced, fold and store it in a separate place.

Keep the pool sections and parts in their original containers.

Keep the sections and parts of the pool in a dry and covered place.

If any of the pool elements are damaged, replace them as soon as possible with original **TOI** accessories. See the address at the end of this manual.

Assembled pool start up.

You should start up the pool at the beginning of the season. The proper procedure must be followed to avoid problems during the period of the year that the pool is used.

- a) Check that your pool equipment (filter, skimmer, cartridges) are in good condition and work correctly.
- b) If necessary, drain the pool and wash the liner with water and neutral soap. The liner must be cleaned when the sun is low. Maintain the walls and floor wet. Leave the product for a while and then rinse with water.
- c) When the liner is completely clean, fill up the pool.
- d) Begin the chlorination treatment. If it takes more than a day to fill up the pool, add the chlorine gradually throughout this time.
- e) To maintain the water in optimum condition, analyze the water pH and make sure it is between 7.2 and 7.6.

To reassemble your pool, follow the instructions beginning from the 'INSTALLATION' section.

For further information please contact us:

Crystalclear Enterprises
Hamilton Lodge
58 Queens Road
Chadderton
Oldham
Tel. 0161 345 1110
E-Mail: sales@cheshireluxurypools.co.uk
www.cheshireluxurypools.co.uk